



Catalogo novità 2025



**Ci muoviamo
alla velocità della Luce**

Prodotti

Lampade LED

Faretti ad incasso soffitto

pag 19



11000/BNC
Lampada LED
Cambiato **TRIS**
con sistema **cambiawatt**

11024/BNC
Lampada LED
Cambiato **TRIS**
con sistema **cambiawatt**

11025/BNC ECO
Lampada LED
Cambiato **TRIS**
con sistema **cambiawatt**

pag 23



11003/BNC ECO
Lampada LED
Cambiato **TRIS**
con sistema **cambiawatt**

11004/BNC ECO
Lampada LED
Cambiato **TRIS**
con sistema **cambiawatt**

11005/BNC ECO
Lampada LED
Cambiato **TRIS**
con sistema **cambiawatt**

11006/BNC ECO
Lampada LED
Cambiato **TRIS**
con sistema **cambiawatt**

pag 25



11044/BNC
Lampada LED
Cambiato **TRIS**
con sistema **cambiawatt**

11045/BNC
Lampada LED
Cambiato **TRIS**
con sistema **cambiawatt**

pag 29



11071/BNC
Lampada LED
Cambiato **TRIS**
con sistema **cambiawatt**

11072/BNC
Lampada LED
Cambiato **TRIS**
con sistema **cambiawatt**

11073/BNC
Lampada LED
Cambiato **TRIS**
con sistema **cambiawatt**

pag 31



1053/BNC ECO
Lampada LED
Cambiato **TRIS**
con sistema **cambiawatt**

pag 35



1083/BNC
Lampada LED
Cambiato **TRIS**

pag 37



1518-36-45/BNC
Plafoniera LED stagna
Cambiato **TRIS**

pag 40



8005/OS
Incasso soffitto
tondo fisso
Oro Satinato

8006/OS
Incasso soffitto
tondo orientabile
Oro Satinato

pag 41



8007/OS
Incasso soffitto
quadrato fisso
Oro Satinato

8008/OS
Incasso soffitto
quadrato orientabile
Oro Satinato

pag 44



8020
Incasso soffitto
tondo orientabile UGR

pag 45

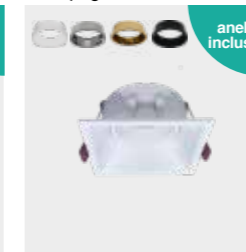

8021
Incasso soffitto
quadrato orientabile UGR

Pannelli/Plafoniere/Cappelloni LED

pag 47



3019/BNC SE
Pannello LED back light
Cambiato **TRIS**
con sistema **cambiawatt**

pag 49



3020/N UGR
Pannello LED UGR<19

pag 50

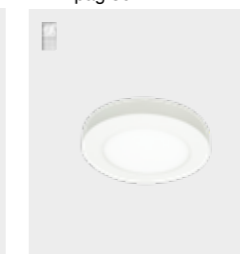

2051/BNC
Plafoniera LED FaStone®
Cambiato **TRIS**

pag 51

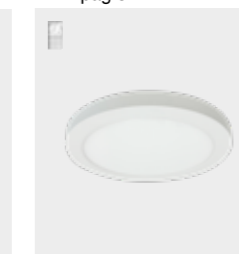

2052/BNC
Plafoniera LED FaStone®
Cambiato **TRIS**



2053/BNC
Plafoniera LED FaStone®
Cambiato **TRIS**

pag 52



2035/BNC/RGB
Pannello LED tondo
Cambiato **TRIS**
+ **RGB** in backside

pag 53



2036/BNC/RGB
Pannello LED tondo
Cambiato **TRIS**
+ **RGB** in backside

pag 57



4270/BNC
Plafoniera LED stagna
Cambiato **TRIS**
con sistema **cambiawatt**

pag 60



4011/BNC
Cappellone LED
Cambiato **TRIS**
con sistema **cambiawatt**

pag 61

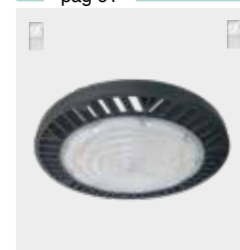

4012/BNC
Cappellone LED
Cambiato **TRIS**
con sistema **cambiawatt**

pag 62



5040/BNC
Appliche slim LED a parete
diretta/indiretta
Cambiatono **TR/S**

5041/BNC
Appliche slim LED a parete
diretta/indiretta
Cambiatono **TR/S**

5042/BNC
Appliche slim LED a parete
diretta/indiretta
Cambiatono **TR/S**

5043/BNC
Appliche slim LED a parete
diretta/indiretta
Cambiatono **TR/S**

pag 64



5024/BNC
Appliche parete LED
diretta/indiretta
Cambiatono **TR/S**
con alette regolabili

5025/BNC
Appliche parete LED
diretta/indiretta
Cambiatono **TR/S**
con alette regolabili

pag 63

Proiettori

pag 68



7206/BNC
Proiettore LED ECO 10W
Cambiatono **TR/S**
Cornice Nera

7208/BNC
Proiettore LED ECO 30W
Cambiatono **TR/S**
Cornice Nera

pag 69



7209/BNC
Proiettore LED ECO 50W
Cambiatono **TR/S**
Cornice Nera

7210/BNC
Proiettore LED ECO 100W
Cambiatono **TR/S**
Cornice Nera

7220/BNC
Proiettore LED ECO 200W
Cambiatono **TR/S**
Cornice Nera

pag 71



70060
Proiettore LED 6W
Cambiatono
con pannello fotovoltaico

70080
Proiettore LED 10W
Cambiatono
con pannello fotovoltaico

pag 72

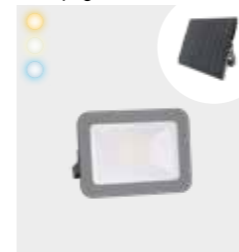

7040/BNC
Proiettore LED Cambiatono 40W
Predisposto per
pannelli LED fotovoltaici Stone®

7040/BNC
Proiettore LED Cambiatono 60W
Predisposto per
pannelli LED fotovoltaici Stone®

pag 73



7100/BNC
Proiettore LED Cambiatono 100W
Predisposto per
pannelli LED fotovoltaici Stone®

7200/BNC
Proiettore LED Cambiatono 200W
Predisposto per
pannelli LED fotovoltaici Stone®

7400/BNC
Proiettore LED Cambiatono 400W
Predisposto per
pannelli LED fotovoltaici Stone®

pag 75



SOLAR 40W
Pannello fotovoltaico
in monocristallino predisposto
per proiettori LED Stone®

SOLAR 60W
Pannello fotovoltaico
in monocristallino predisposto
per proiettori LED Stone®

SOLAR 100W
Pannello fotovoltaico
in monocristallino predisposto
per proiettori LED Stone®

pag 75



SOLAR 200W
Pannello fotovoltaico
in monocristallino predisposto
per proiettori LED Stone®

SOLAR 300W
Pannello fotovoltaico
in monocristallino predisposto
per proiettori LED Stone®

SOLAR 400W
Pannello fotovoltaico
in monocristallino predisposto
per proiettori LED Stone®

pag 78



BOX SOLAR/5
Cavo splitter
per 5 proiettori

pag 79

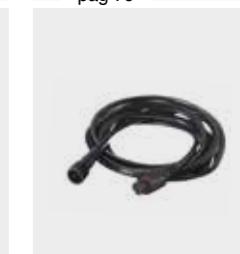

CAVO SOLAR/1-2-3-5-10
Cavo per pannello solare
1 metro >10 metri

pag 81

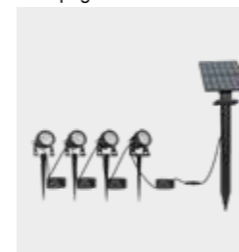

24000/N-C
Kit 4 proiettori LED
a picchetto in alluminio
con pannello fotovoltaico

pag 83



20201/BNC
Palo LED Solare
da giardino in alluminio
Cambiatono

pag 85



20202/BNC
Palo LED Solare
da giardino in alluminio
Cambiatono

pag 89



6200/BNC
Strip LED COB **IP20**
Cambiatono **TR/S**



6201/BNC
Strip LED COB **IP68**
Cambiatono **TR/S**

pag 91

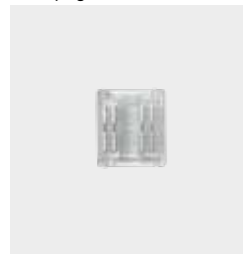

66014
Connettore lineare
strip COB/ strip COB BNC

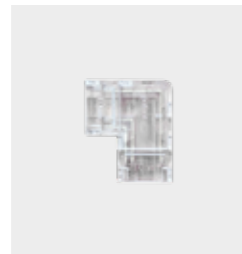

66015
Connettore angolare
strip COB/ strip COB BNC

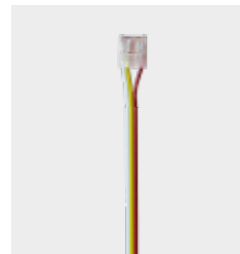

66016
Connettore trasformatore
strip COB/ strip COB BNC



66017
Connettore
strip COB/ strip COB BNC

pag 95

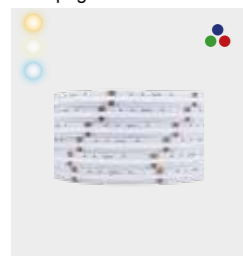

6134/RGB/BNC/24V
Strip LED COB **IP20**
Cambiatono **TR/S + RGB**



66020
Connettore lineare
strip COB/
strip COB BNC+ **RGB**



66021
Connettore flessibile terminale
strip COB/
strip COB BNC+ **RGB**



66022
Connettore flessibile intermedio
strip COB/
strip COB BNC+ **RGB**

pag 101



6000/RGB/BNC
Controller
per Strip LED BNC
e BNC + **RGB**

pag 105



60891
Giunto di collegamento
lineare
Strip LED COB 220V



60901
Giunto di collegamento
angolare
Strip LED COB 220V



60902
Giunto di collegamento
da 12 mm
Strip LED COB 220V

pag 103



60541
Bobina da 50 mt - K6500
Strip LED COB 220V - **IP68**



60551
Bobina da 50 mt - K4000
Strip LED COB 220V - **IP68**

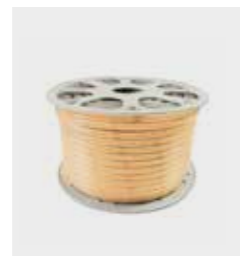

60561
Bobina da 50 mt - K3000
Strip LED COB 220V - **IP68**

pag 105



60851
Cavo
Strip LED COB 220V

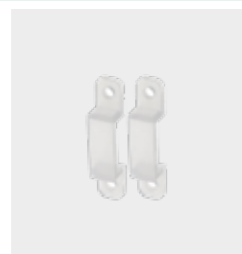

6086
Clips di montaggio
Strip LED COB 220V



6087
Silicone
Strip LED COB 220V



60881
Tappi di chiusura
Strip LED COB 220V

Stone[®] introduce il rivoluzionario sistema **Cambiatono e Cambiawatt**

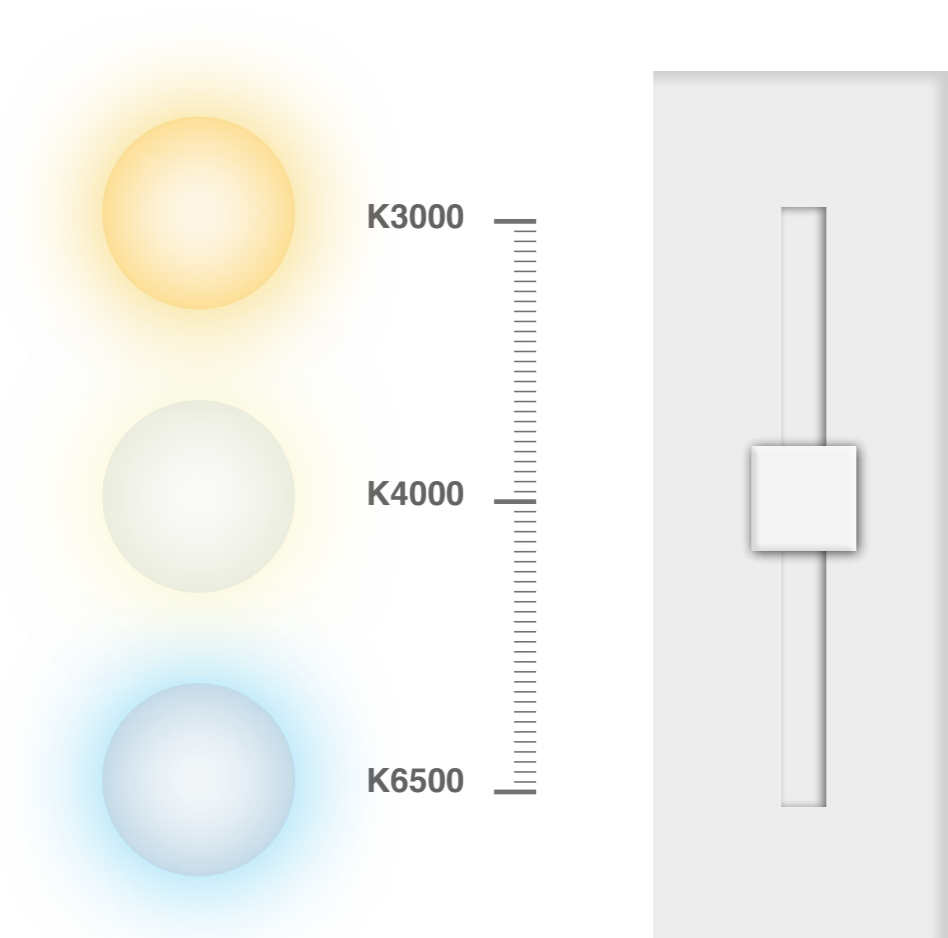

Scelta della temperatura
(Kelvin)

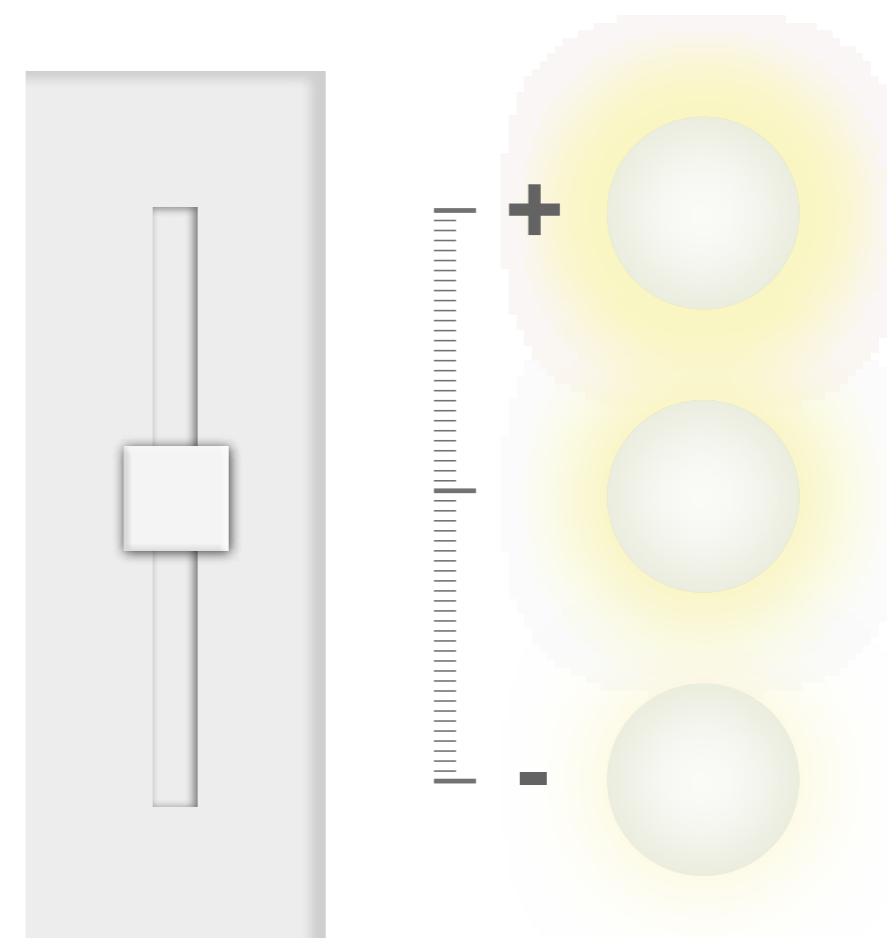

Scelta della potenza
(Watt)



Scegliere non è mai stato così **semplice**



sistema ad interruttore **+**
Cambiwatt **-**

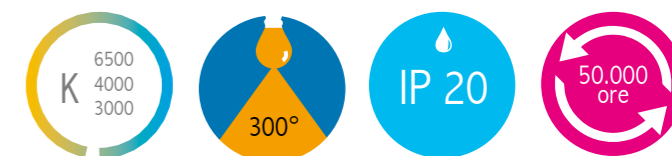

kelvin	K6500 + K4000 + K3000
watt	15W + 18W + 21W
lumen	1500 + 1800 + 2100
attacco	E27
grado di protezione	IP20
angolo	300°
corpo	PVC
autonomia	50.000 ore

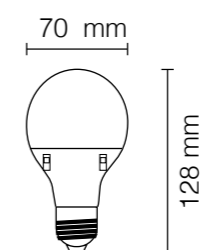

11000/BNC

Lampada LED Goccia Cambiatono **TRIS** con sistema **cambiwatt**

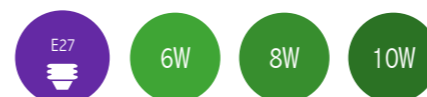

kelvin	K6500 + K4000 + K3000
watt	6W + 8W + 10W
lumen	600 + 800 + 1000
attacco	E27
grado di protezione	IP20
angolo	300°
corpo	PVC
autonomia	50.000 ore

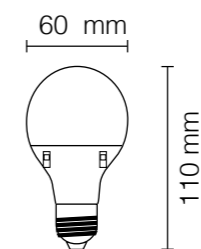

11024/BNC

Lampada LED Goccia Cambiatono **TRIS** con sistema **cambiwatt**



kelvin	K6500 + K4000 + K3000
watt	10W + 12W + 15W
lumen	1000 + 1200 + 1500
attacco	E27
grado di protezione	IP20
angolo	300°
corpo	PVC
autonomia	50.000 ore

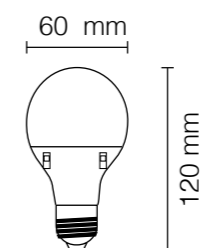

11025/BNC ECO

Lampada LED Goccia Cambiatono **TRIS** con sistema **cambiwatt**

K3000



K4000



K6500



- watt



+ watt



**Cambiatono
TRIS**

sistema ad interruttore **+**
Cambiawatt **-**

Sistema
Brevettato

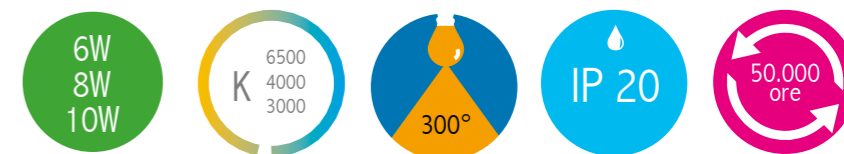

kelvin	K6500 + K4000 + K3000
watt	6W + 8W + 10W
lumen	600 + 800 + 1000
attacco	E27
grado di protezione	IP20
angolo	300°
corpo	PVC
autonomia	50.000 ore

45 mm

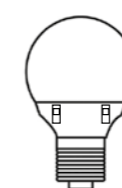

75 mm



11003/BNC ECO

Lampada LED
Cambiatono **TRIS**
con sistema **cambiawatt**



kelvin	K6500 + K4000 + K3000
watt	6W + 8W + 10W
lumen	600 + 800 + 1000
attacco	E27
grado di protezione	IP20
angolo	300°
corpo	PVC
autonomia	50.000 ore

45 mm



78 mm



11004/BNC ECO

Lampada LED
Cambiatono **TRIS**
con sistema **cambiawatt**



kelvin	K6500 + K4000 + K3000
watt	6W + 8W + 10W
lumen	600 + 800 + 1000
attacco	E14
grado di protezione	IP20
angolo	200°
corpo	PVC
autonomia	70.000 ore

37 mm



131 mm



11005/BNC ECO

Lampada LED
Cambiatono **TRIS**
con sistema **cambiawatt**



kelvin	K6500 + K4000 + K3000
watt	6W + 8W + 10W
lumen	600 + 800 + 1000
attacco	E14
grado di protezione	IP20
angolo	200°
corpo	PVC
autonomia	70.000 ore

37 mm

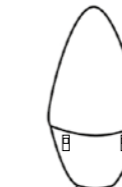

97,5 mm



11006/BNC ECO

Lampada LED
Cambiatono **TRIS**
con sistema **cambiawatt**

Lampade LED Cambiatono *TRIS*



Cambiatono
TRIS

sistema ad interruttore
Cambiawatt

Sistema
Brevettato

Lampade LED Cambiatono *TRIS* con sistema Cambiawatt



kelvin	K6500 + K4000 + K3000
watt	24W + 27W + 30W
lumen	2700 + 3050 + 3400
attacco	E27
grado di protezione	IP20
angolo	300°
corpo	PVC
autonomia	50.000 ore



kelvin	K6500 + K4000 + K3000
watt	30W + 33W + 36W
lumen	3300 + 3650 + 4000
attacco	E27
grado di protezione	IP20
angolo	300°
corpo	PVC
autonomia	50.000 ore

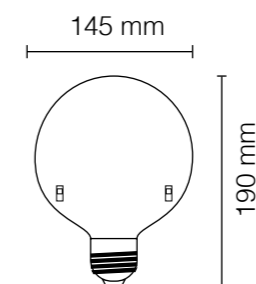
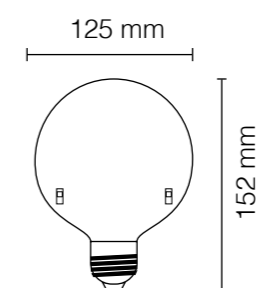

11044/BNC

Lampada LED Globo
Cambiatono *TRIS*
con sistema *cambiawatt*

11045/BNC

Lampada LED Globo
Cambiatono *TRIS*
con sistema *cambiawatt*



Lampade LED Cambiatono *TRIS*

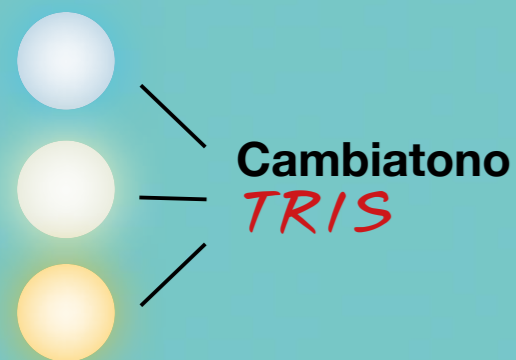

sistema ad interruttore **+**
Cambiwatt **-**

Sistema
Brevettato

Lampade LED Cambiatono *TRIS* con sistema **Cambiwatt**

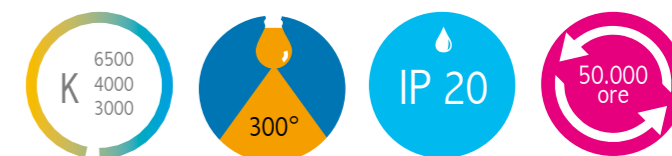

kelvin	K6500 + K4000 + K3000
watt	8W + 10W + 12W
lumen	800 + 1000 + 1200
attacco	E14
grado di protezione	IP20
angolo	300°
corpo	PVC
autonomia	50.000 ore

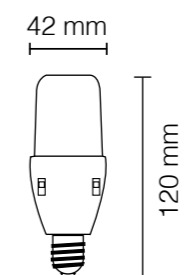

11071/BNC

Lampada LED
Cambiatono *TRIS*
con sistema **cambiwatt**



kelvin	K6500 + K4000 + K3000
watt	8W + 10W + 12W
lumen	800 + 1000 + 1200
attacco	E27
grado di protezione	IP20
angolo	300°
corpo	PVC
autonomia	50.000 ore

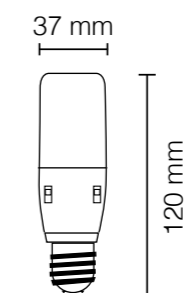

11072/BNC

Lampada LED
Cambiatono *TRIS*
con sistema **cambiwatt**



kelvin	K6500 + K4000 + K3000
watt	13W + 15W + 17W
lumen	1300 + 1500 + 1700
attacco	E27
grado di protezione	IP20
angolo	300°
corpo	PVC
autonomia	50.000 ore

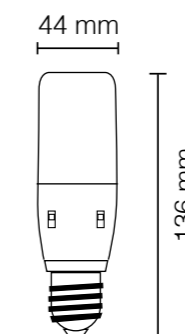

11073/BNC

Lampada LED
Cambiatono *TRIS*
con sistema **cambiwatt**

Lampada LED Cambiatono *TRIS*

sistema ad interruttore **+**
Cambiwatt **-**

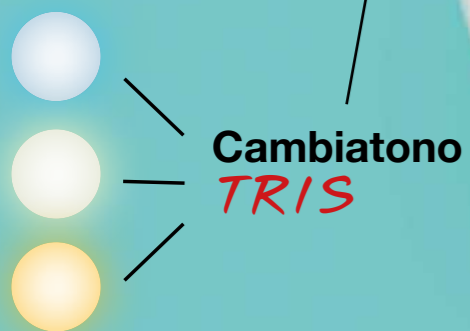

Lampada LED Cambiatono *TRIS* con sistema Cambiwatt



kelvin	K6500 + K4000 + K3000
watt	4,5W + 7,5W + 8,5W
lumen	500 + 800 + 900
attacco	GU10
grado di protezione	IP20
angolo	120°
corpo	PVC
autonomia	50.000 ore

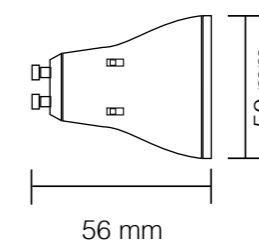

1053/BNC ECO

Lampada LED
Cambiatono *TRIS*
con sistema **cambiwatt**

K6500



K4000

3000

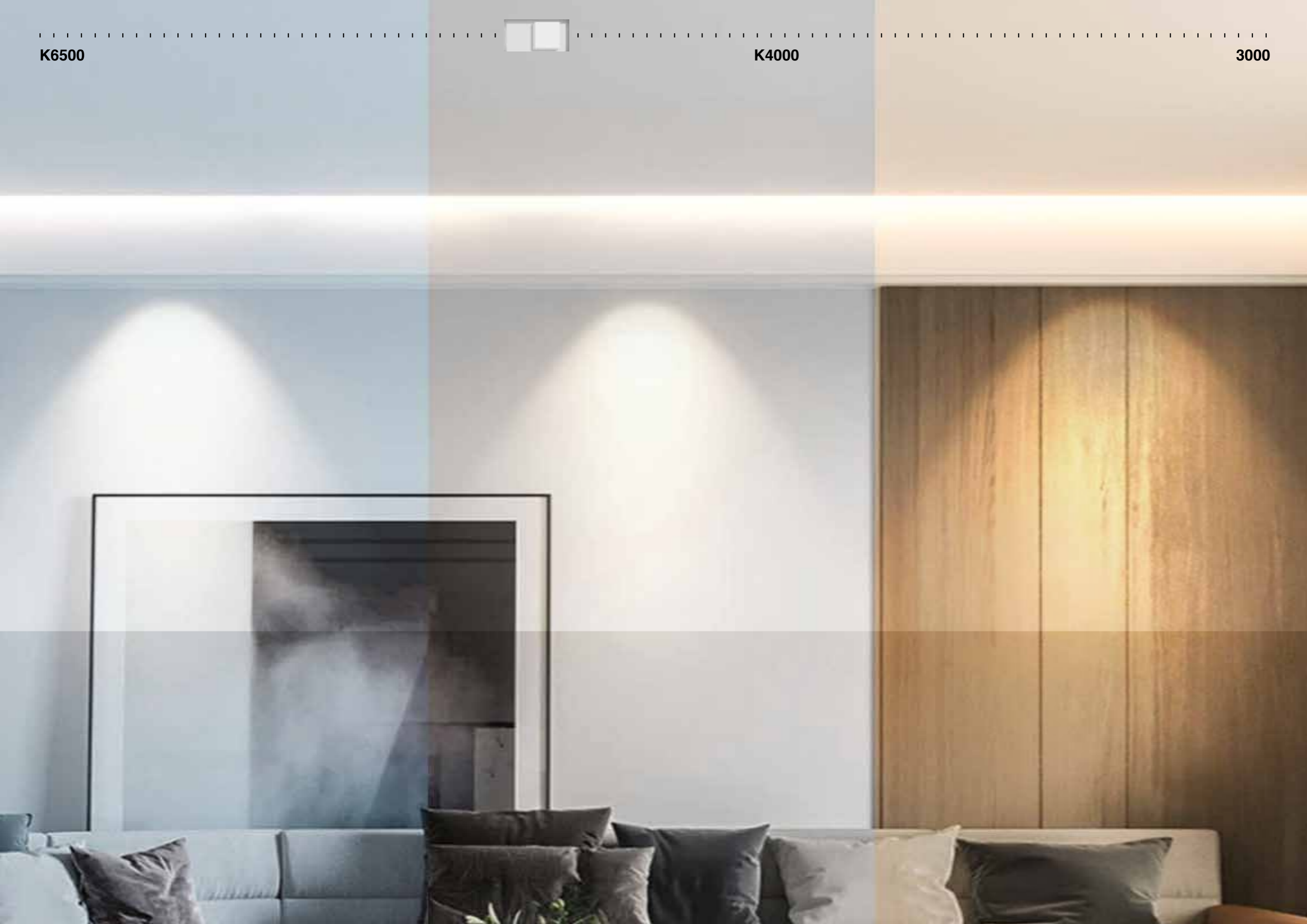

Lampada LED Cambiatono *TRIS*



Cambiatono
TRIS



Lampada LED Cambiatono *TRIS*

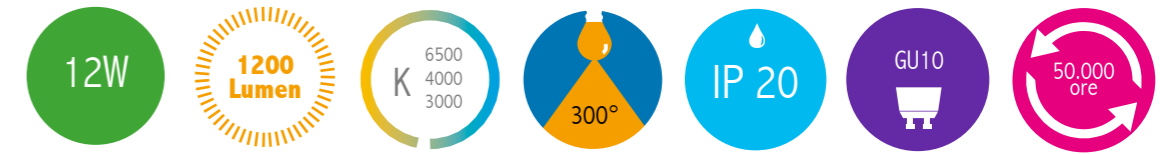

kelvin	K6500 + K4000 + K3000
watt	12W
lumen	1400
attacco	GU10
grado di protezione	IP20
angolo	120°
corpo	PVC
autonomia	50.000 ore

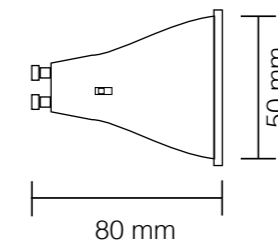

1083/BNC

Lampada LED
Cambiatono *TRIS*

Plafoniera LED Stagna Cambiatono *TRIS*



sistema
cambiatono
TRIS

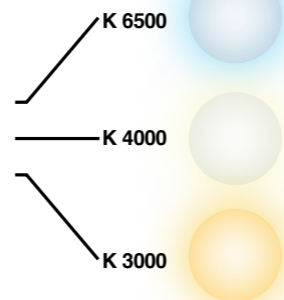

Plafoniera LED Stagna Cambiatono *TRIS*

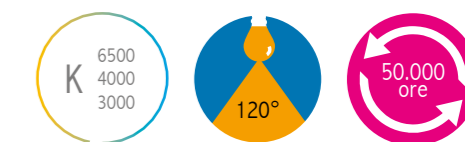

kelvin	6500K + 4000K + 3000K
watt	18W
lumen	2400
grado di protezione	IP65
angolo	120°
corpo	policarbonato
riflettore	satinato
autonomia	50.000 ore



1518/BNC

Plafoniera LED Stagna
Cambiatono *TRIS*



kelvin	6500K + 4000K + 3000K
watt	36W
lumen	4800
grado di protezione	IP65
angolo	120°
corpo	policarbonato
riflettore	satinato
autonomia	50.000 ore



1536/BNC

Plafoniera LED Stagna
Cambiatono *TRIS*



kelvin	6500K + 4000K + 3000K
watt	45W
lumen	5900
grado di protezione	IP65
angolo	120°
corpo	policarbonato
riflettore	satinato
autonomia	50.000 ore

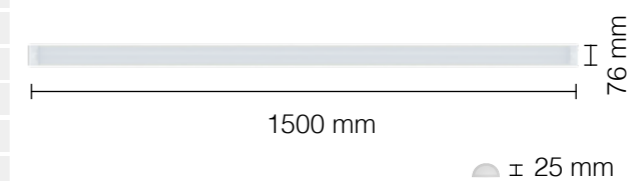

1545/BNC

Plafoniera LED Stagna
Cambiatono *TRIS*

sistema
cambiatono
TRIS

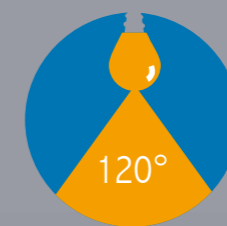

Incassi soffitto tondi con sistema Stay On



con pratico sistema
Stay On



8005/OS

Incasso soffitto tondo
fisso



foro: 58 mm

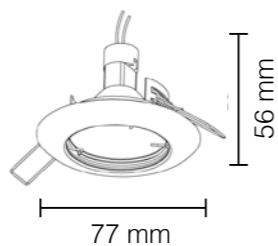

colore oro satinato
attacco GU10
grado di protezione IP20
corpo alluminio

- Portalamпада GU10 compreso

8006/OS

Incasso soffitto tondo
orientabile



foro: 68 mm

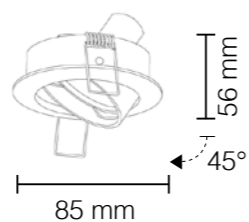

colore oro satinato
attacco GU10
grado di protezione IP20
corpo alluminio

- Portalamпада GU10 compreso

Incassi soffitto quadrati con sistema Stay On



con pratico sistema
Stay On



colore oro satinato
attacco GU10
grado di protezione IP20
corpo alluminio

- Portalamпада GU10 compreso

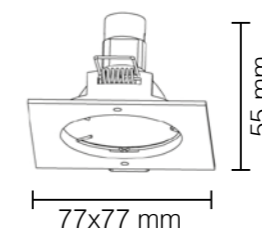

foro: 60 mm

8007/OS

Incasso soffitto quadrato
fisso

colore oro satinato
attacco GU10
grado di protezione IP20
corpo alluminio

- Portalamпада GU10 compreso

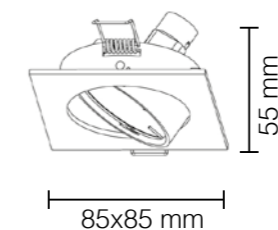

foro: 75 mm

8008/OS

Incasso soffitto quadrato
orientabile

Incassi soffitto tondi
con sistema **Stay On**



Incassi soffitto quadrati
con sistema **Stay On**



colori disponibili



colori disponibili



Incasso soffitto tondo orientabile

4 anelli intercambiabili
inclusi nella confezione



8020

Incasso soffitto tondo
orientabile UGR



foro: 80 mm

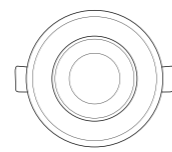
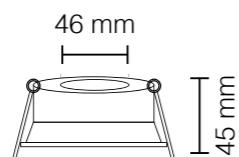

93 mm

grado di protezione	IP20
corpo	alluminio
IUA (Indice Unificato Abbagliamento)	UGR<19
Anelli	Bianco
	Cromo
	Oro Lucido
	Nero

- Anelli intercambiabili inclusi
- Portalampana GU10 incluso

Incasso soffitto quadrato orientabile

4 anelli intercambiabili
inclusi nella confezione



grado di protezione	IP20
corpo	alluminio
IUA (Indice Unificato Abbagliamento)	UGR<19
Anelli	Bianco
	Cromo
	Oro Lucido
	Nero

- Anelli intercambiabili inclusi
- Portalampana GU10 incluso

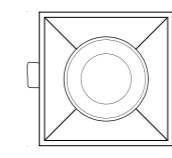
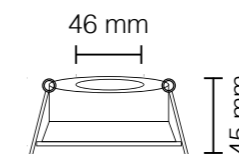

90 mm



foro: 80x80 mm

8021

Incasso soffitto quadrato
orientabile UGR

Pannello LED Back Light Cambiatono *TRIS* con sistema Cambiawatt

Pannello LED Back Light Cambiatono *TRIS* con sistema Cambiawatt

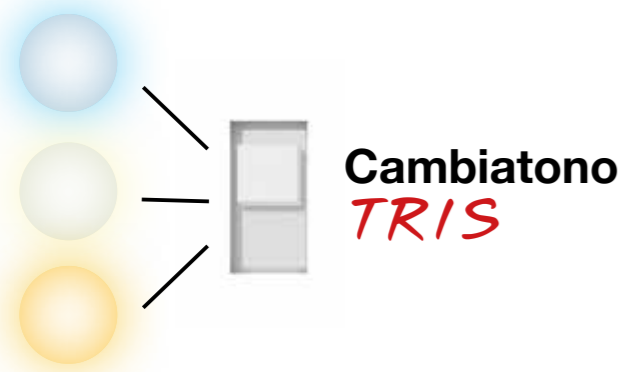

Il prodotto non deve superare le **12 ore** di funzionamento giornaliero

sistema ad interruttore
Cambiawatt



Durata utile (valore L)

Con il parametro "L", si determina quindi la percentuale di decadimento del flusso luminoso riferito alle ore di funzionamento utili (normalmente 50.000 ore). Con L80:50000h viene stabilito che, raggiunto 50.000 h di funzionamento, il modulo LED fornisce ancora l'80% del flusso luminoso iniziale.

Aspettativa di vita del LED (valore B)

Nei dati caratteristici del LED, il valore B seguito da un valore normalmente compreso tra 10 e 50 indica la qualità del componente utilizzato in quanto definisce la percentuale di componenti che, allo scadere delle normali 50.000 ore, non mantengono le caratteristiche di flusso luminoso dichiarate. Un LED dichiarato L80/B20=50.000 ore indica che al raggiungimento delle 50.000 ore l'80% (B20) dei componenti presenta un flusso luminoso residuo pari o superiore all'80% del flusso iniziale (L80).



kelvin	K6500 + K4000 + K3000
watt	36W + 42W + 50W
lumen	3600 + 4200 + 5000
grado di protezione	IP20
fattore di potenza	PF 0.9
indice resa cromatica	CRI 80
angolo	120°
corpo	alluminio
cornice	bianca
autonomia	50.000 ore

● Trasformatore elettronico compreso (esterno)

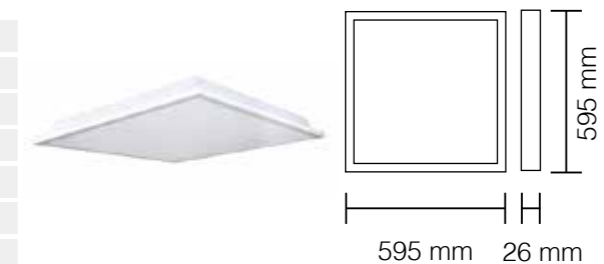

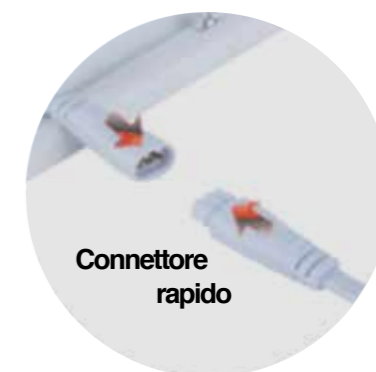
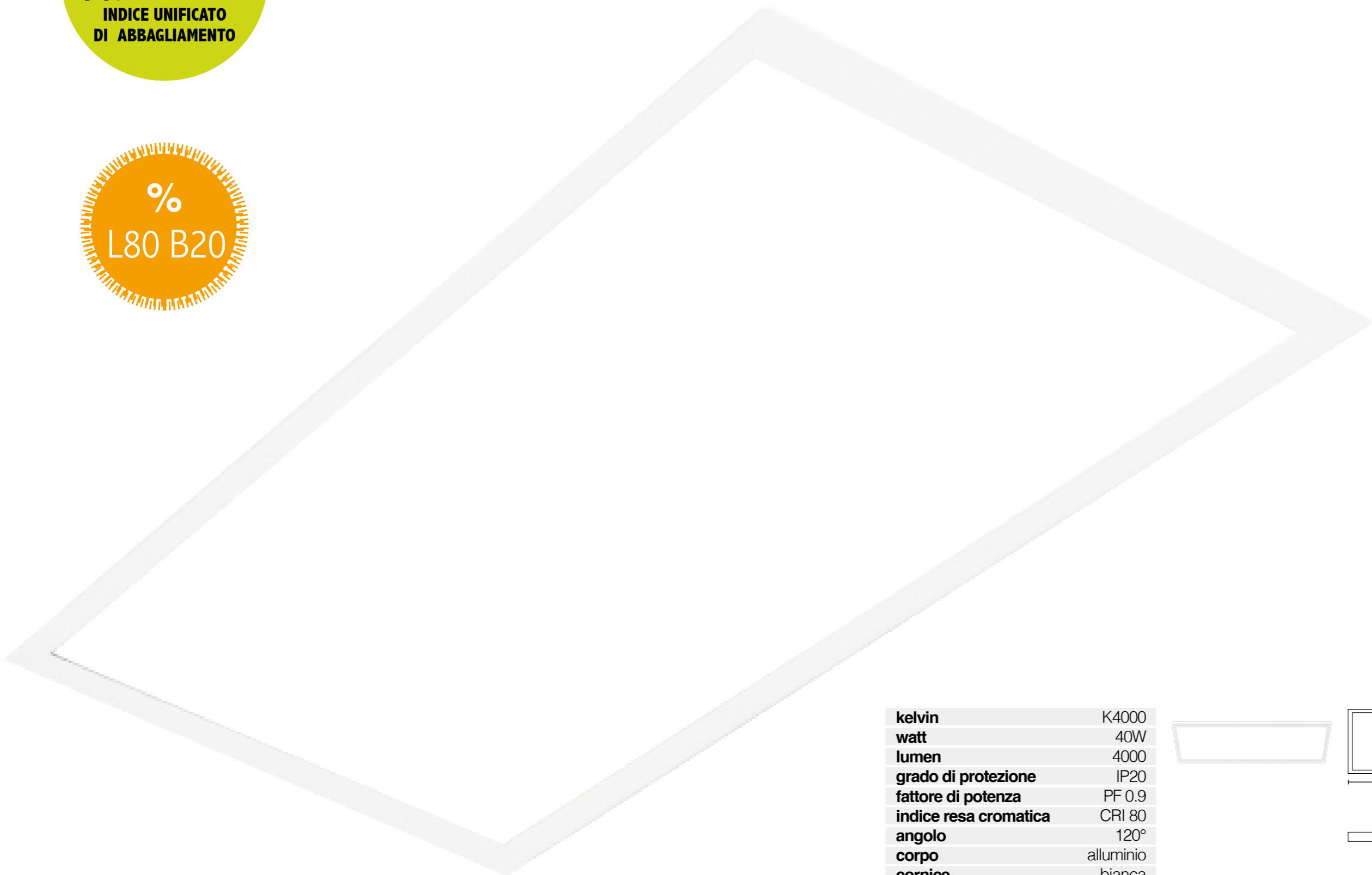

kelvin	K4000
watt	40W
lumen	4000
grado di protezione	IP20
fattore di potenza	PF 0.9
indice resa cromatica	CRI 80
angolo	120°
corpo	alluminio
cornice	bianca
autonomia	50.000 ore

● Trasformatore elettronico compreso (esterno)

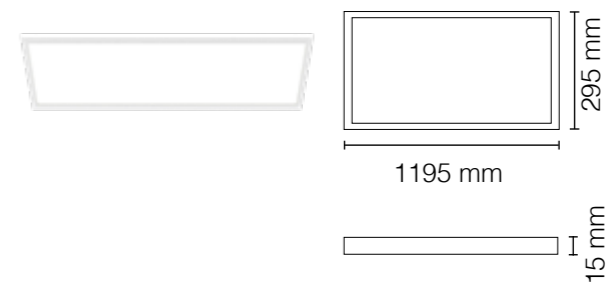

3020/N UGR

Pannello LED UGR rettangolare

Plafoniera LED faStone® Cambiatono TRIS

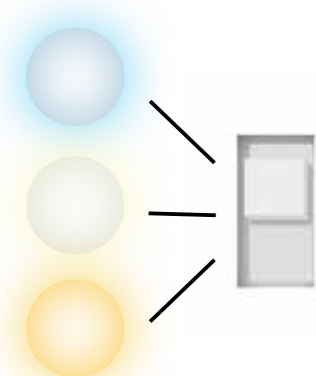

Cambiatono
TRIS

con sistema di installazione
faStone



2051/BNC

Plafoniera LED FaStone
Cambiatono **TRIS**

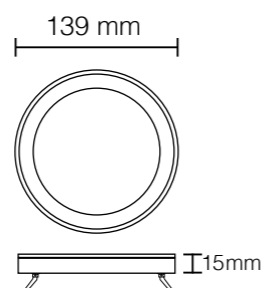

12W



kelvin	K6500 + K4000 + K3000
watt	12W
lumen	1500
grado di protezione	IP44
angolo	120°
corpo	PVC
cornice	bianca
autonomia	50.000 ore

Plafoniera LED faStone® Cambiatono TRIS

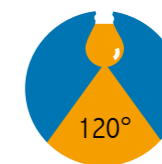

18W



kelvin	K6500 + K4000 + K3000
watt	18W
lumen	2200
grado di protezione	IP44
angolo	120°
corpo	PVC
cornice	bianca
autonomia	50.000 ore

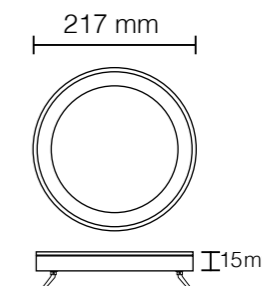

2052/BNC

Plafoniera LED FaStone
Cambiatono **TRIS**

24W



kelvin	K6500 + K4000 + K3000
watt	24W
lumen	2800
grado di protezione	IP44
angolo	120°
corpo	PVC
cornice	bianca
autonomia	50.000 ore

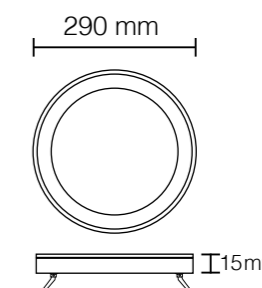

2053/BNC

Plafoniera LED FaStone
Cambiatono **TRIS**

Plafoniera tonda LED Cambiatono **TRIS** + **Cambiwatt** + **RGB** in backside

Plafoniera tonda LED Cambiatono **TRIS** + **Cambiwatt** + **RGB** in backside

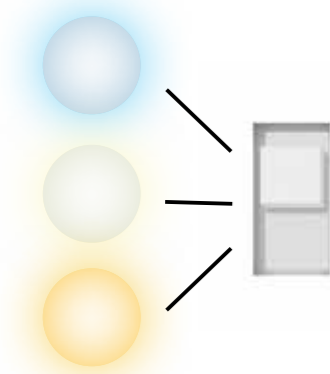

Cambiatono
TRIS

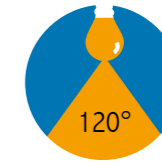

sistema ad interruttore
Cambiwatt



RGB
in Backside

2035/BNC/RGB

Plafoniera LED tonda
Cambiatono **TRIS**
con sistema **cambiwatt**
RGB in backside

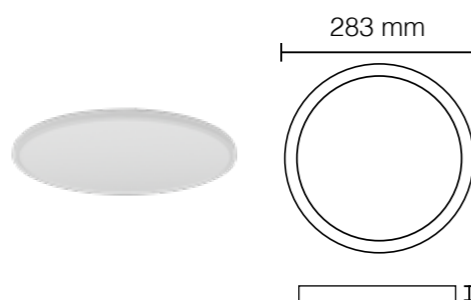

16W 20W 24W

kelvin	K6500+K4000+K3000+RGB
watt	16W + 20W + 24W
lumen	2000 + 2500 + 3000
grado di protezione	IP44
angolo	120°
corpo	PVC
cornice	bianca
autonomia	50.000 ore

● Telecomando incluso

24W 28W 32W

kelvin	K6500+K4000+K3000+RGB
watt	24W + 28W + 32W
lumen	3000 + 3600 + 4000
grado di protezione	IP44
angolo	120°
corpo	PVC
cornice	bianca
autonomia	50.000 ore

● Telecomando incluso

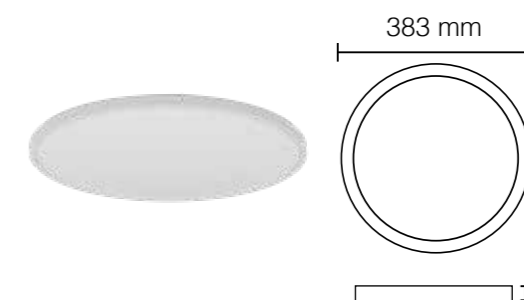

2036/BNC/RGB

Plafoniera LED tonda
Cambiatono **TRIS**
con sistema **cambiwatt**
RGB in backside



Plafoniera tonda LED Cambiatono **TRIS** + Cambiawatt + RGB

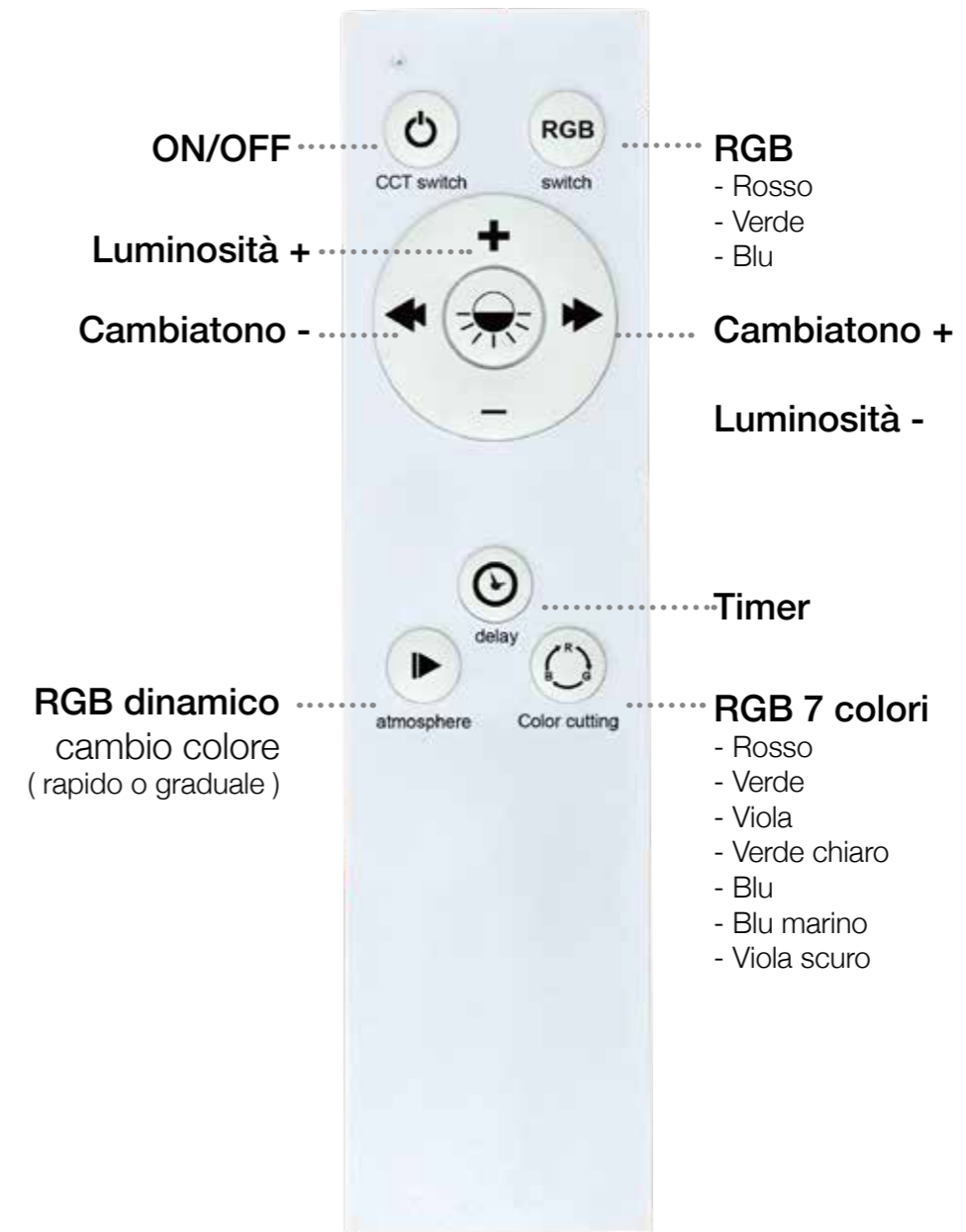

Telecomando incluso

RGB
in Backside



Plafoniera stagna LED Cambiatono **TRIS UNICA** con sistema **Cambiwatt**



+ sistema ad interruttore
- **Cambiwatt**

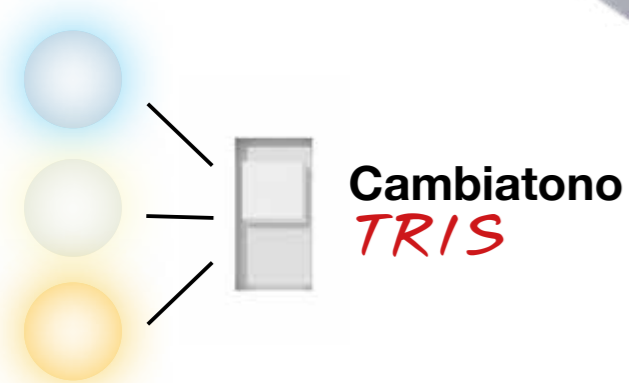

Plafoniera stagna LED Cambiatono **TRIS UNICA** con sistema **Cambiwatt**

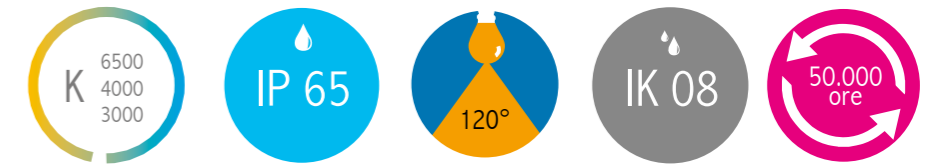

Lo schermo in **policarbonato opalino** riesce a diffondere la luce a **120°** senza significative perdite di luminosità



LED Ultrabright
di ultima generazione

kelvin	K6500 + K4000 + K3000
watt	40W + 50W + 60W+ 70W
lumen	7000+ 8000+ 9000+10000
grado di protezione	IP65
resistenza all'urto	IK 08
angolo	120°
corpo	policarbonato
schermo	policarbonato opalino
colore	grigio chiaro
autonomia	50.000 ore

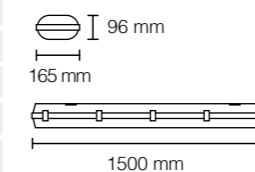

4270/BNC
Plafoniera stagna LED
Cambiatono **TRIS**
con sistema **cambiwatt**

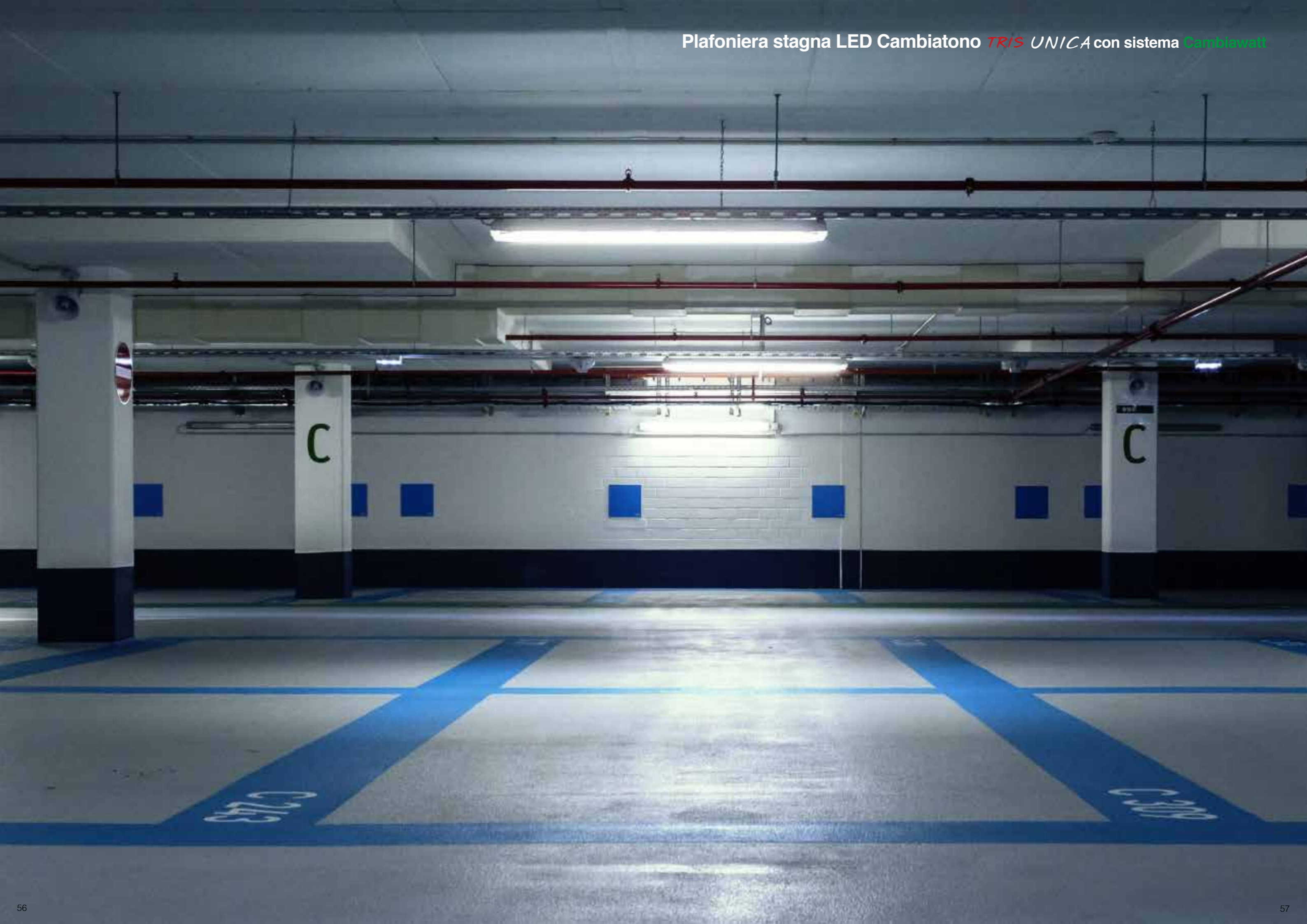

Cappellone LED Cambiatono *TRIS* + Cambiawatt

Cappellone LED Cambiatono *TRIS* + Cambiawatt

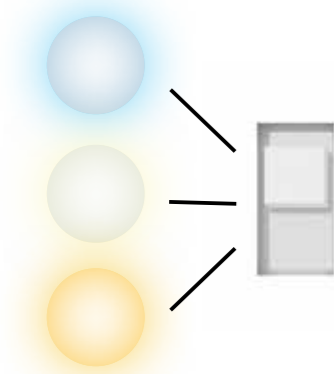

Cambiatono
TRIS

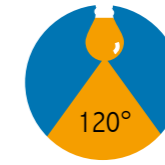

sistema ad interruttore
Cambiawatt



4011/BNC

Cappellone LED
Cambiatono *TRIS*
con sistema **cambiawatt**

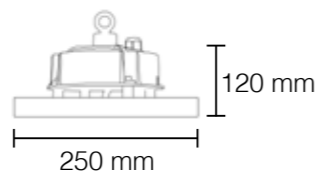

60W 80W 100W

kelvin	K6500+K4000+K3000
watt	60W + 80W + 100W
lumen	9900 + 13200 + 16500
grado di protezione	IP65
angolo	120°
corpo	alluminio
schermo	PVC
autonomia	50.000 ore

120W 160W 200W

kelvin	K6500+K4000+K3000
watt	120W + 160W + 200W
lumen	19800 + 26000 + 33000
grado di protezione	IP65
angolo	120°
corpo	alluminio
schermo	PVC
autonomia	50.000 ore

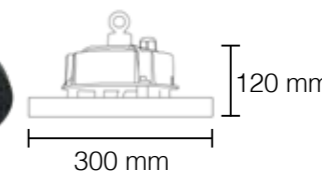

4012/BNC

Cappellone LED
Cambiatono *TRIS*
con sistema **cambiawatt**

Applique slim a parete diretta/indiretta Cambiatono TRIS



5040/BNC

Applique slim a parete
Cambiatono TRIS

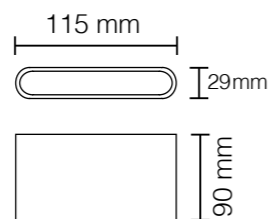

3x2W



kelvin	K6500 + K4000 + K3000
watt	3x2W
lumen	900
grado di protezione	IP65
luce	diretta/Indiretta
corpo	alluminio
colore	bianco
autonomia	50.000 ore

5041/BNC

Applique slim a parete
Cambiatono TRIS

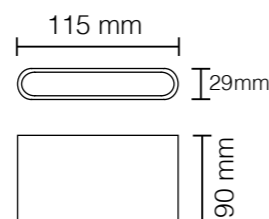

3x2W



kelvin	K6500 + K4000 + K3000
watt	3x2W
lumen	900
grado di protezione	IP65
luce	diretta/Indiretta
corpo	alluminio
colore	grigio scuro
autonomia	50.000 ore

Applique slim a parete diretta/indiretta Cambiatono TRIS



6x2W



kelvin	K6500 + K4000 + K3000
watt	6x2W
lumen	1800
grado di protezione	IP65
luce	diretta/Indiretta
corpo	alluminio
colore	bianco
autonomia	50.000 ore

5042/BNC

Plafoniera LED FaStone
Cambiatono TRIS

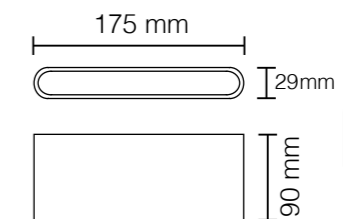

6x2W



kelvin	K6500 + K4000 + K3000
watt	6x2W
lumen	1800
grado di protezione	IP65
luce	diretta/Indiretta
corpo	alluminio
colore	grigio scuro
autonomia	50.000 ore

5043/BNC

Plafoniera LED FaStone
Cambiatono TRIS

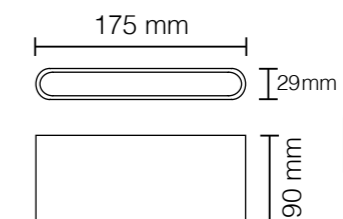

Applique parete LED diretta/indiretta Cambiatono *TRIS*

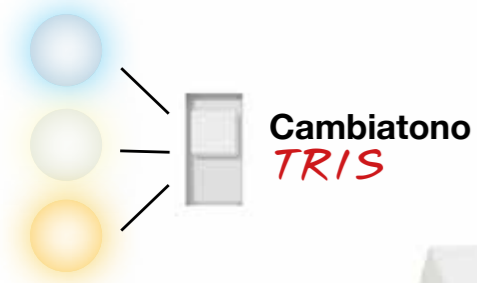

5024/BNC

Applique parete LED
Cambiatono *TRIS*
con alette regolabili

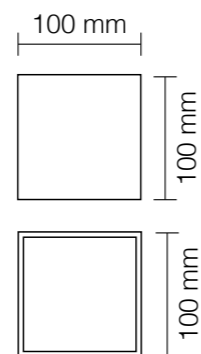

kelvin	K6500 + K4000 + K3000
watt	6W
lumen	800
grado di protezione	IP65
corpo	alluminio
colore	bianco
luce	diretta/indiretta
autonomia	50.000 ore

- Possibilità di regolare il fascio di luce da 5° a 45° manualmente

Applique parete LED diretta/indiretta Cambiatono *TRIS*



5025/BNC

Applique parete LED
Cambiatono *TRIS*
con alette regolabili

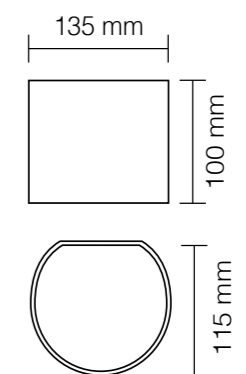

kelvin	K6500 + K4000 + K3000
watt	6W
lumen	800
grado di protezione	IP65
corpo	alluminio
colore	bianco
luce	diretta/indiretta
autonomia	50.000 ore

- Possibilità di regolare il fascio di luce da 5° a 45° manualmente

Applique parete LED diretta/indiretta Cambiatono *TRIS*

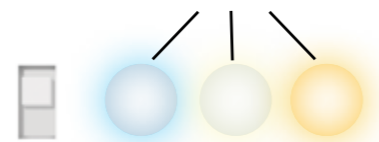

Applique parete LED diretta/indiretta Cambiatono *TRIS*

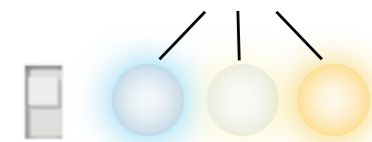

Fascio di luce regolabile manualmente da 5° a 45°

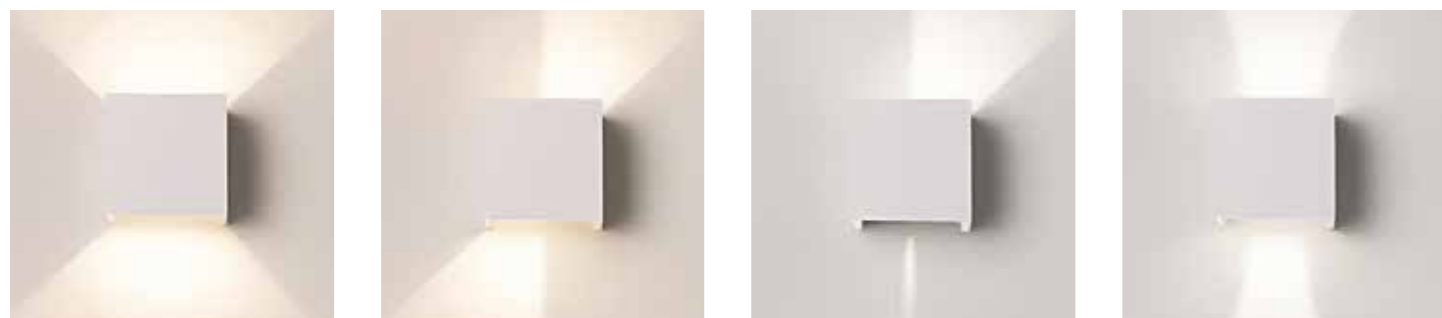

Fascio di luce regolabile manualmente da 5° a 45°



Proiettori LED ECO Cambiatono TRIS

Cornice Nera



System Valve

L'apparecchio monta una valvola di respirazione impermeabile antideflagrante per la fuoriuscita della condensa

7206/BNC

Proiettore LED ECO Cambiatono TRIS

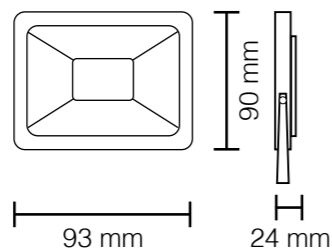

10W 1000 Lumen

kelvin	K6500 + K4000 + K3000
watt	10W
lumen	1000
grado di protezione	IP65
Indice resa cromatica	Ra>80
angolo	120°
corpo	alluminio pressofuso
cornice	nera
vetro	vetro temperato trasparente
autonomia	50.000 ore

7208/BNC

Proiettore LED ECO Cambiatono TRIS

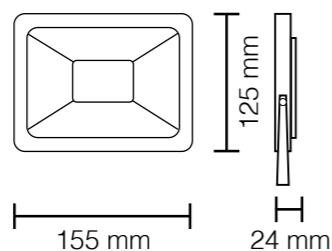

30W 3000 Lumen

kelvin	K6500 + K4000 + K3000
watt	30W
lumen	3000
grado di protezione	IP65
Indice resa cromatica	Ra>80
angolo	120°
corpo	alluminio pressofuso
cornice	nera
vetro	vetro temperato trasparente
autonomia	50.000 ore

Proiettori LED ECO Cambiatono TRIS

Cornice Nera

Cambiatono TRIS

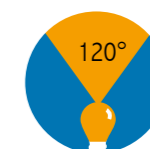
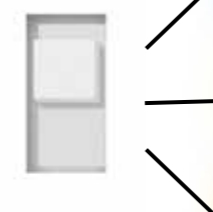

50W 5000 Lumen

kelvin	K6500 + K4000 + K3000
watt	50W
lumen	5000
grado di protezione	IP65
Indice resa cromatica	Ra>80
angolo	120°
corpo	alluminio pressofuso
cornice	nera
vetro	vetro temperato trasparente
autonomia	50.000 ore

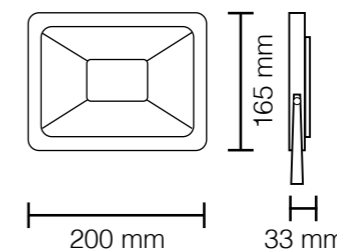

7209/BNC

Proiettore LED ECO Cambiatono TRIS

100W 10000 Lumen

kelvin	K6500 + K4000 + K3000
watt	100W
lumen	10000
grado di protezione	IP65
Indice resa cromatica	Ra>80
angolo	120°
corpo	alluminio pressofuso
cornice	nera
vetro	vetro temperato trasparente
autonomia	50.000 ore

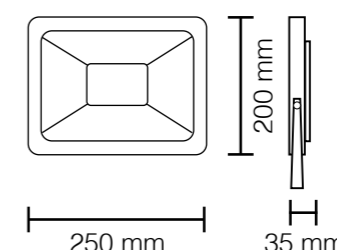

7210/BNC

Proiettore LED ECO Cambiatono TRIS

200W 20000 Lumen

kelvin	K6500 + K4000 + K3000
watt	200W
lumen	20000
grado di protezione	IP65
Indice resa cromatica	Ra>80
angolo	120°
corpo	alluminio pressofuso
cornice	nera
vetro	vetro temperato trasparente
autonomia	50.000 ore

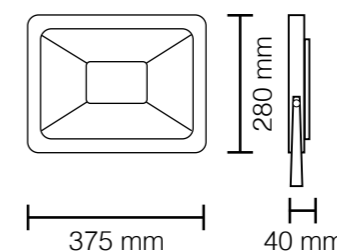

7220/BNC

Proiettore LED ECO Cambiatono TRIS

Proiettore LED Cambiatono con pannello fotovoltaico

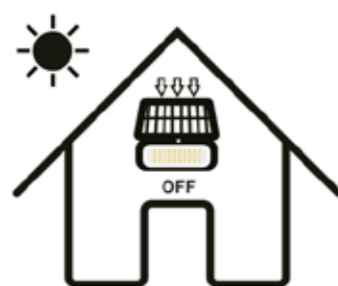

Carica



20% Luminosità



100% Luminosità

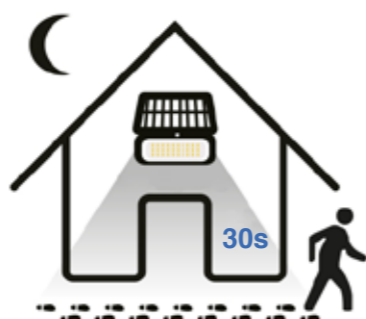

20% Luminosità

Proiettore LED Cambiatono con pannello fotovoltaico



Batteria sostituibile



kelvin	K6500 + K4000 + K3000
watt	6W
lumen	200
batteria	3.7V/2200mAh
pannello solare	1,75W 5V
angolo	120°
carica	6H
durata	12H

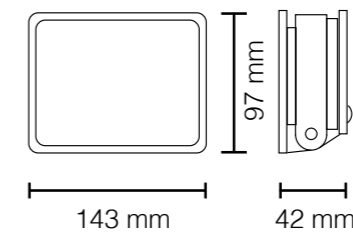

70060

Proiettore LED Cambiatono con pannello fotovoltaico



kelvin	K6500 + K4000 + K3000
watt	10W
lumen	380
batteria	3.7V/2600mAh
pannello solare	2,5W 5V
angolo	120°
carica	6H
durata	12H

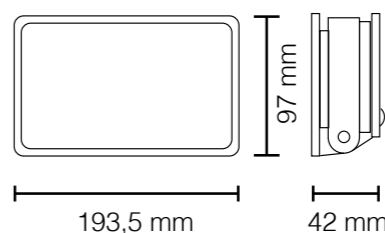

70080

Proiettore LED Cambiatono con pannello fotovoltaico

Proiettori LED Cambiatono predisposti per pannelli fotovoltaici Stone®



possono essere utilizzati
esclusivamente con i pannelli
fotovoltaici Stone®



Cambiatono

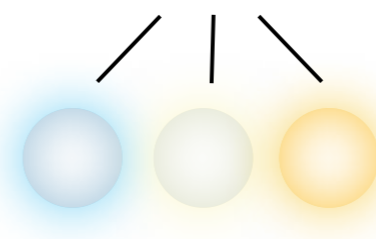

Proiettori LED Cambiatono predisposti per pannelli fotovoltaici Stone®



kelvin	K6500 + K4000 + K3000
watt	100W
lumen	2500
angolo	120°
carica (tramite pannello fotovoltaico)	5H
durata (tramite pannello fotovoltaico)	18H

- Predisposto per pannello fotovoltaico Stone®
cod. **Solar 100 - 200 - 300 - 400**

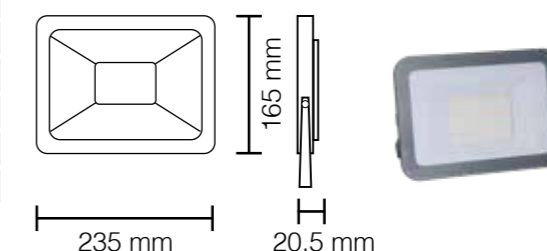

7100/BNC

Proiettore LED Cambiatono
predisposto per
pannello fotovoltaico Stone®



kelvin	K6500 + K4000 + K3000
watt	40W
lumen	1000
angolo	120°
carica (tramite pannello fotovoltaico)	5H
durata (tramite pannello fotovoltaico)	18H

- Predisposto per pannello fotovoltaico Stone®
cod. **Solar 40 - 60 - 100 - 200 - 300 - 400**

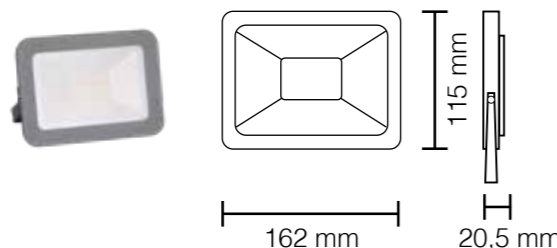

7040/BNC

Proiettore LED Cambiatono
predisposto per
pannello fotovoltaico Stone®



kelvin	K6500 + K4000 + K3000
watt	200W
lumen	5000
angolo	120°
carica (tramite pannello fotovoltaico)	5H
durata (tramite pannello fotovoltaico)	18H

- Predisposto per pannello fotovoltaico Stone®
cod. **Solar 200 - 300 - 400**

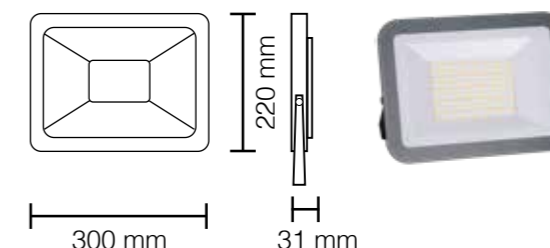

7200/BNC

Proiettore LED Cambiatono
predisposto per
pannello fotovoltaico Stone®



kelvin	K6500 + K4000 + K3000
watt	60W
lumen	1500
angolo	120°
carica (tramite pannello fotovoltaico)	5H
durata (tramite pannello fotovoltaico)	18H

- Predisposto per pannello fotovoltaico Stone®
cod. **Solar 60 - 100 - 200 - 300 - 400**

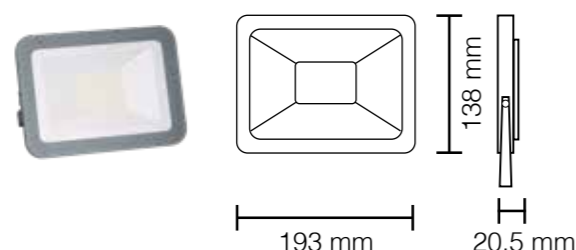

7060/BNC

Proiettore LED Cambiatono
predisposto per
pannello fotovoltaico Stone®



kelvin	K6500 + K4000 + K3000
watt	400W
lumen	10000
angolo	120°
carica (tramite pannello fotovoltaico)	5H
durata (tramite pannello fotovoltaico)	18H

- Predisposto per pannello fotovoltaico Stone®
cod. **Solar 400**

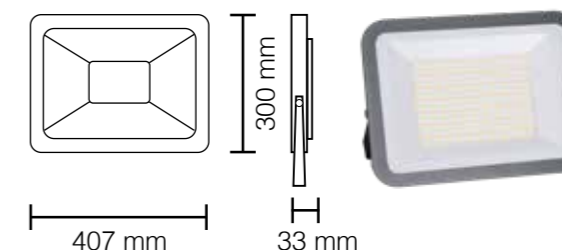

7400/BNC

Proiettore LED Cambiatono
predisposto per
pannello fotovoltaico Stone®

Pannelli fotovoltaici in monocristallino predisposti per proiettori LED Stone®

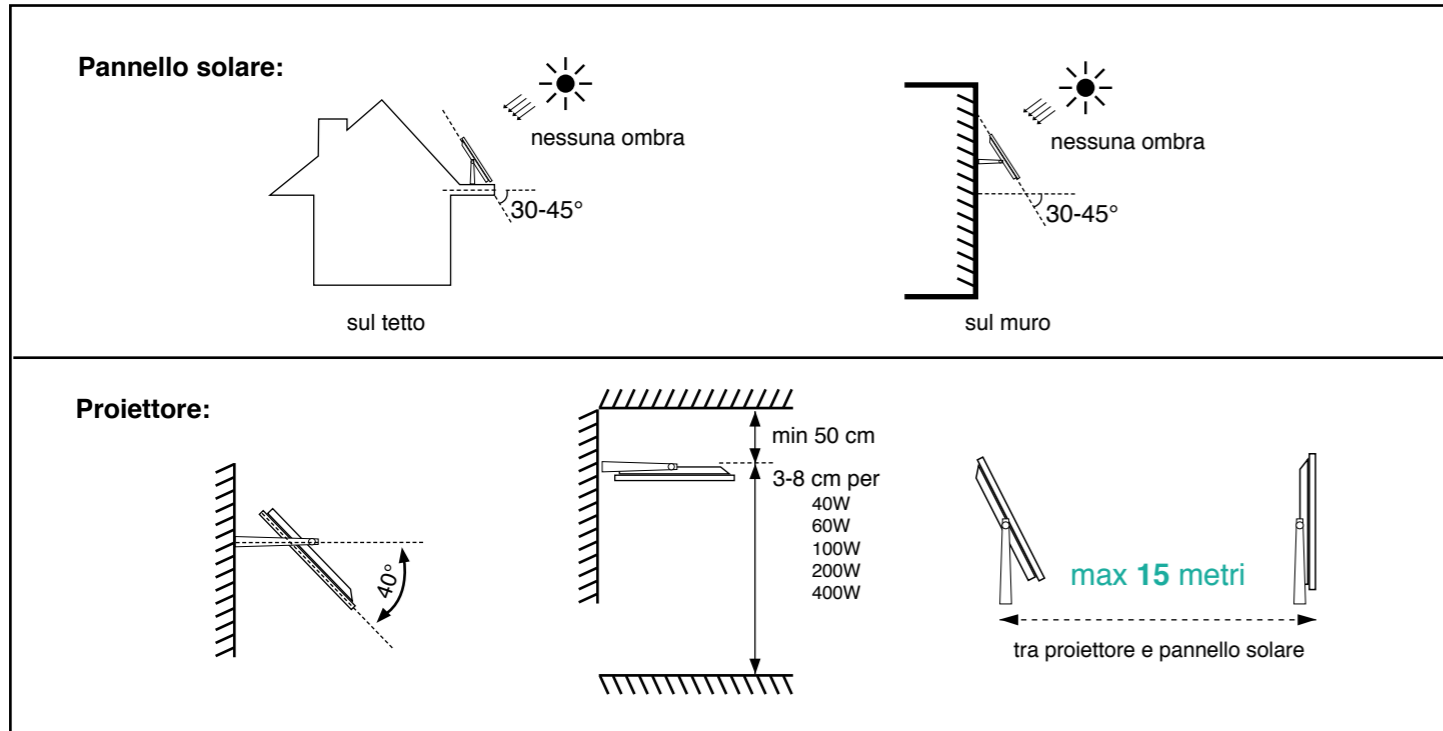

Soluzione per più proiettori

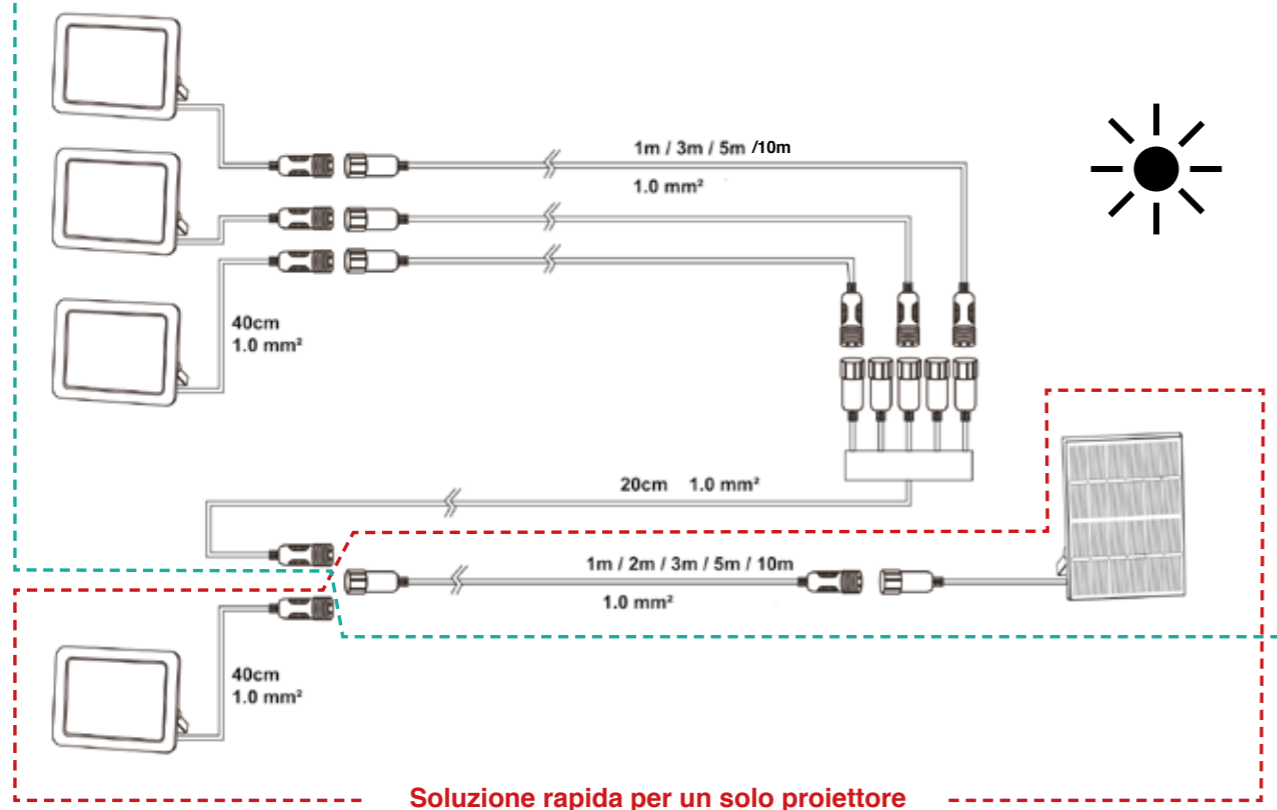

Pannelli fotovoltaici in monocristallino predisposti per proiettori LED Stone®



Batteria LiFePO₄ a bordo
Lithium iron phosphate Battery
ricaricabile e sostituibile



batteria LiFePO₄	10Ah 3.2V
tensione	6V
potenza nominale	40W
carica	5H
durata	18H

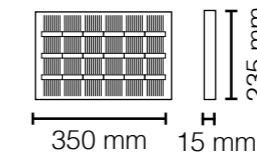

Solar 40

Pannello fotovoltaico in monocristallino predisposto per proiettore LED Stone®

batteria LiFePO₄	10Ah 3.2V
tensione	6V
potenza nominale	60W
carica	5H
durata	18H

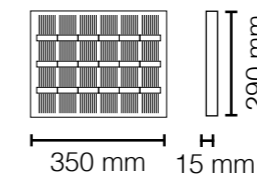

Solar 60

Pannello fotovoltaico in monocristallino predisposto per proiettore LED Stone®

batteria LiFePO₄	15Ah 3.2V
tensione	6V
potenza nominale	100W
carica	5H
durata	18H

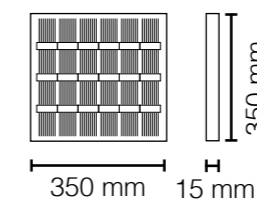

Solar 100

Pannello fotovoltaico in monocristallino predisposto per proiettore LED Stone®

batteria LiFePO₄	20Ah 3.2V
tensione	6V
potenza nominale	200W
carica	5H
durata	18H

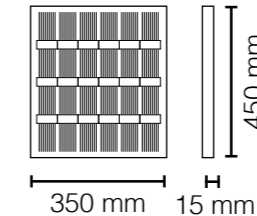

Solar 200

Pannello fotovoltaico in monocristallino predisposto per proiettore LED Stone®

batteria LiFePO₄	25Ah 3.2V
tensione	6V
potenza nominale	300W
carica	5H
durata	18H

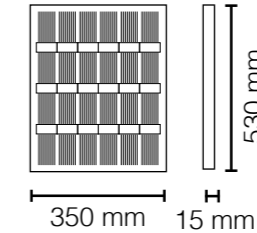

Solar 300

Pannello fotovoltaico in monocristallino predisposto per proiettore LED Stone®

batteria LiFePO₄	30Ah 3.2V
tensione	6V
potenza nominale	400W
carica	5H
durata	18H

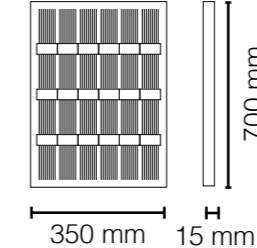

Solar 400

Pannello fotovoltaico in monocristallino predisposto per proiettore LED Stone®



Cavo splitter per 5 proiettori



BOX SOLAR/5

Cavo splitter per 5 proiettori



nr proiettori collegabili 5

Cavo pannello solare



lunghezza 1 metro



CAVO SOLAR/1

Cavo per pannello solare 1 m

lunghezza 2 metri



CAVO SOLAR/2

Cavo per pannello solare 2 m

lunghezza 3 metri



CAVO SOLAR/3

Cavo per pannello solare 3 m

lunghezza 5 metri



CAVO SOLAR/5

Cavo per pannello solare 5 m

lunghezza 10 metri



CAVO SOLAR/10

Cavo per pannello solare 10 m

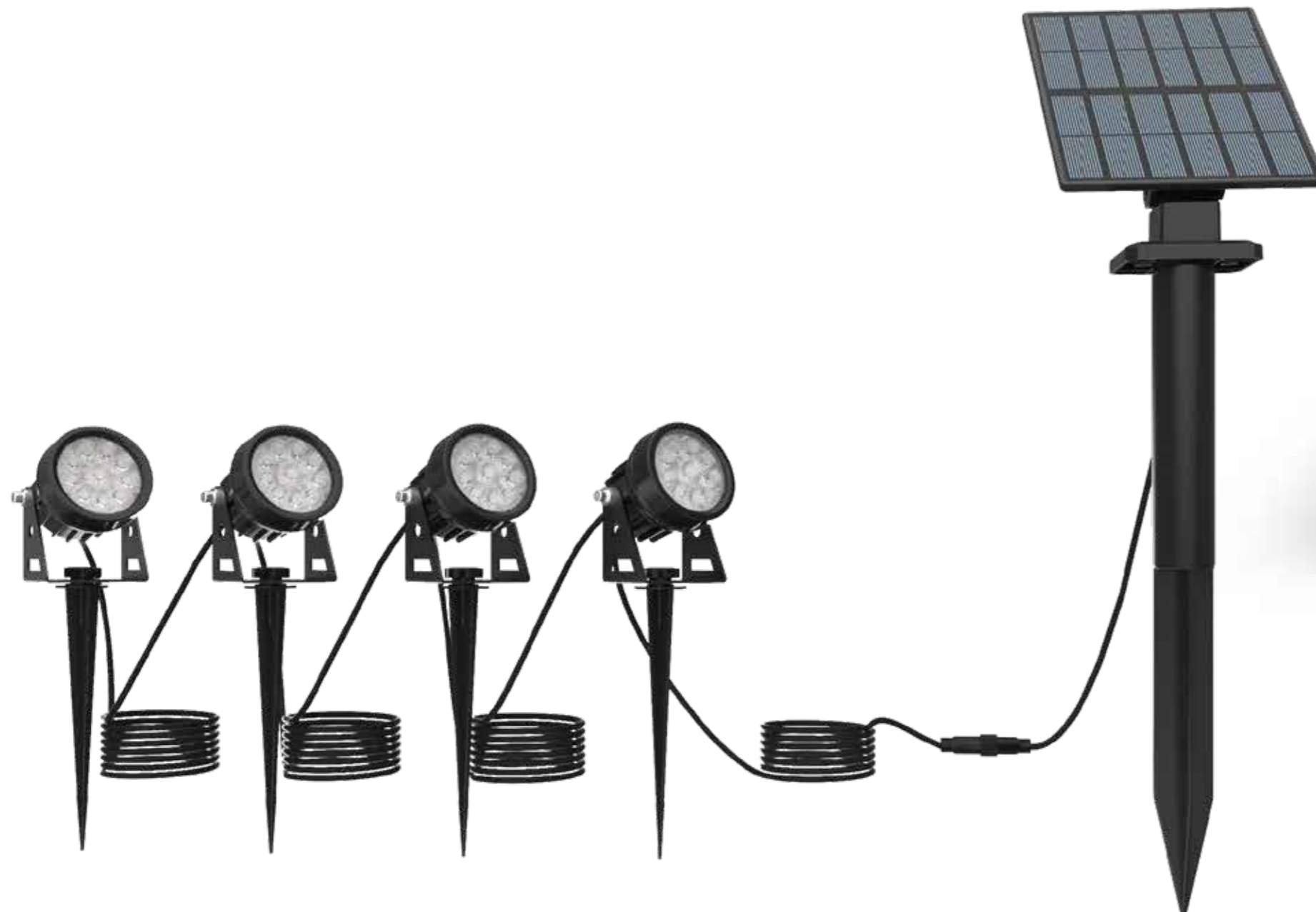

Con tasto di spegnimento ON/OFF per risparmio durata

kelvin	K4000 K3000
watt	4x2W
lumen	4x150
grado di protezione	IP44
accensione	automatica
carica	4H
durata	8H
autonomia	50.000 ore

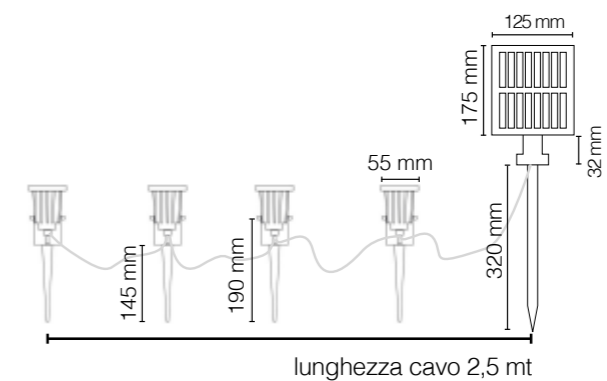

24000/N-C

Kit 4 proiettori LED a picchetto in alluminio con pannello fotovoltaico

Palo LED solare da giardino in alluminio Cambiatono

Palo LED solare da giardino in alluminio Cambiatono



Cambiatono

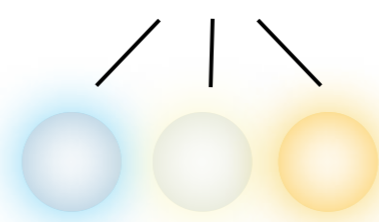

Carica
6h

Durata
15h

Sensore di movimento a micro onde

Batteria sostituibile



100%
luminosità
nel raggio di 3 metri



20%
luminosità
senza presenza umana

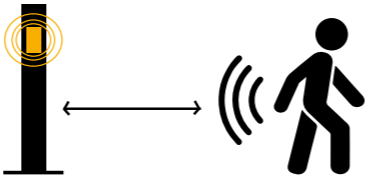

20%
luminosità
entro 30 sec
dall'allontanamento

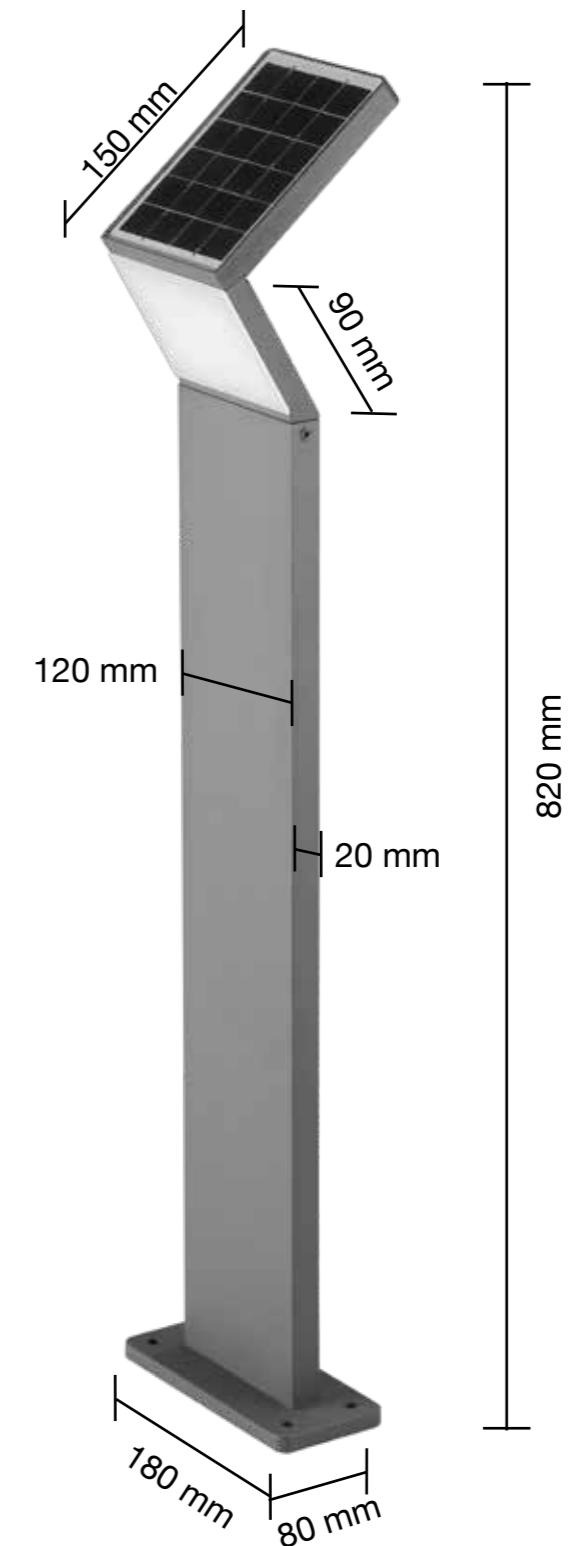

kelvin	K6500 + K4000 + K3000
watt	3W
lumen	300
grado di protezione	IP65
batteria a litio	3,7V/4000mAh
pannello solare	1,8W/5.5V
carica	6H
angolo	120°
senso movimento	micro onde
autonomia	50.000 ore

20201/BNC

Palo LED Solare
da giardino in alluminio
Cambiatono

Palo LED solare da giardino in alluminio Cambiatono

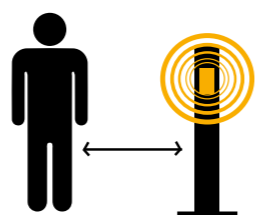

100%
luminosità
nel raggio di 3 metri

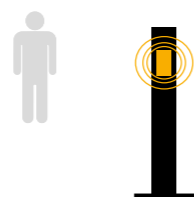

20%
luminosità
senza presenza umana

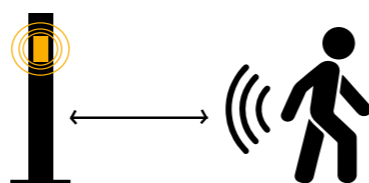

20%
luminosità
entro 30 sec
dall'allontanamento

Palo LED solare da giardino in alluminio Cambiatono

Cambiatono

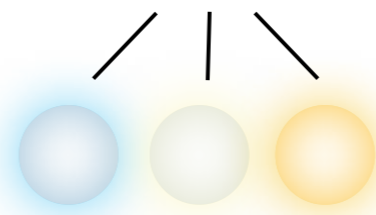

Carica
6h

Durata
15h

Sensore
di movimento
a micro onde

Batteria
sostituibile

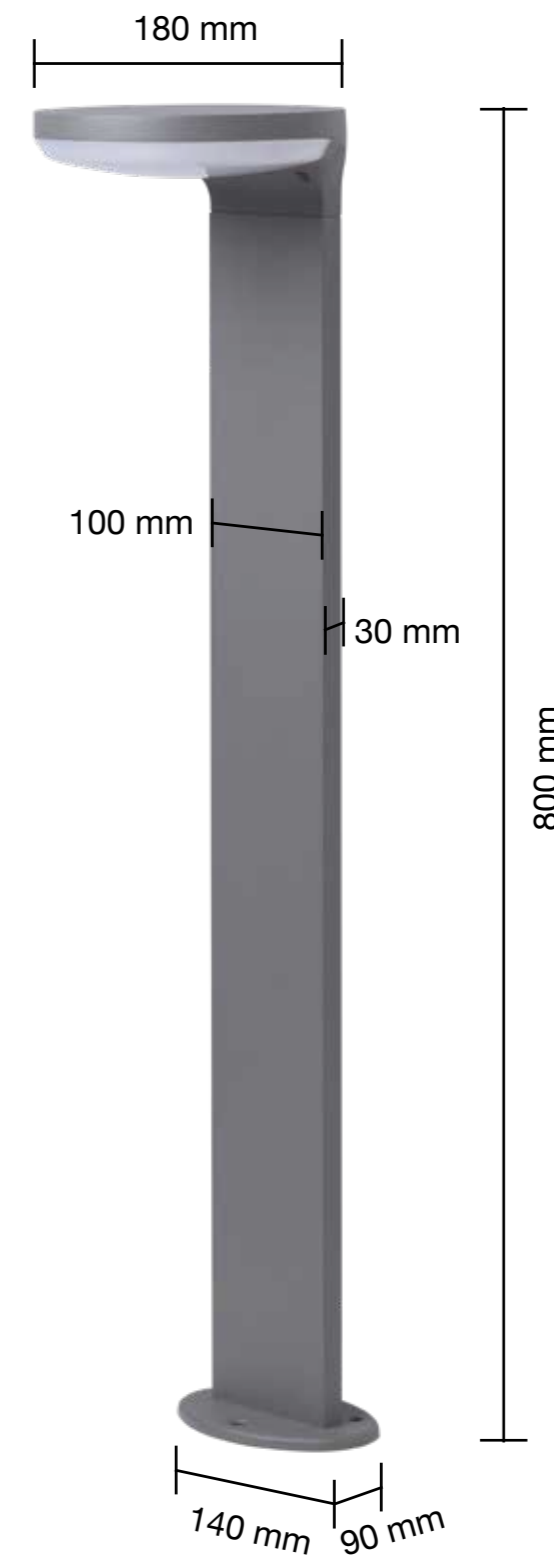

kelvin	K6500 + K4000 + K3000
watt	3W
lumen	300
grado di protezione	IP65
batteria a litio	3,7V/4000mAh
pannello solare	1,8W/5.5V
carica	6H
angolo	120°
senso movimento	micro onde
autonomia	50.000 ore

20202/BNC

Palo LED Solare
da giardino in alluminio
Cambiatono

Palo LED solare da giardino in alluminio Cambiatono

Palo LED solare da giardino in alluminio Cambiatono



Carica **6h** Durata **15h** Sensore di movimento a micro onde Batteria sostituibile

Carica **6h** Durata **15h** Sensore di movimento a micro onde Batteria sostituibile



Cambiatono

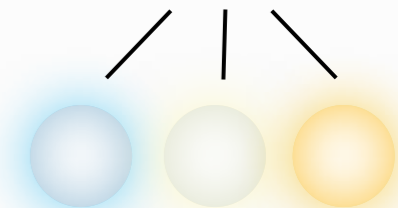

Schema di collegamento

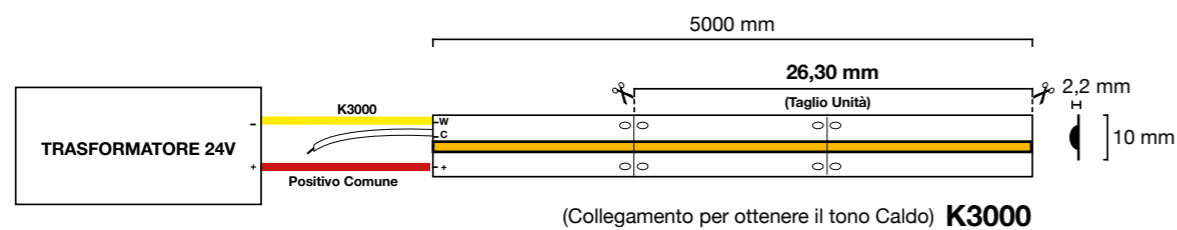
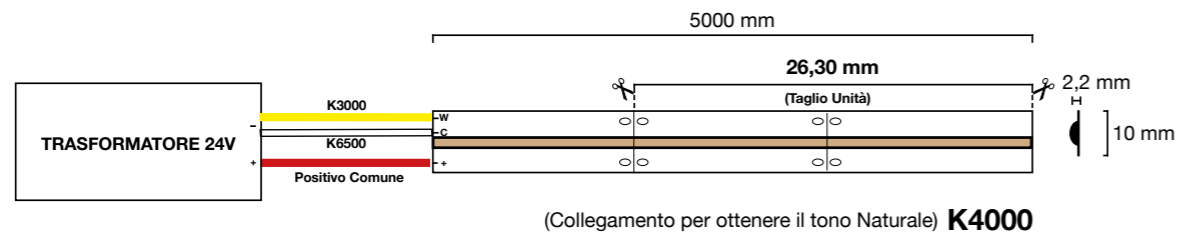
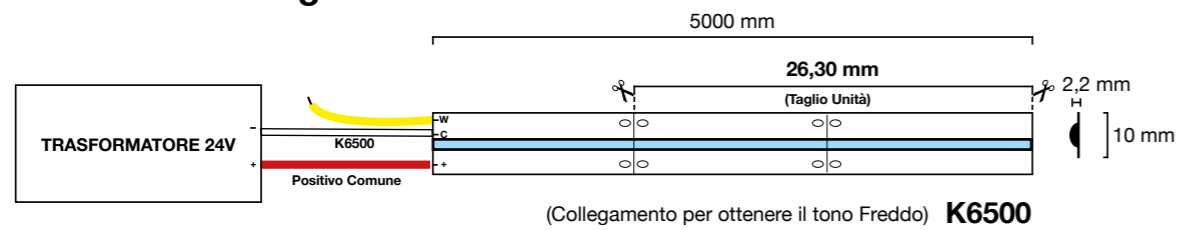

IP20

kelvin	6500K + 3000K + 4000K
watt	15W per metro (75Wx 5m tot)
lumen/metro	2000
grado di protezione	IP20
voltaggio	24V
chip LED	COB
lunghezza	5 metri
nr LED per metro	280 LED/metro
corpo	PCB
autonomia	70.000 ore

IP68

kelvin	6500K + 3000K + 4000K
watt	15W per metro (75Wx 5m tot)
lumen/metro	2000
grado di protezione	IP68
voltaggio	24V
chip LED	COB
lunghezza	5 metri
nr LED per metro	280 LED/metro
corpo	PCB
autonomia	70.000 ore

6200/BNC



Strip LED COB
Cambiatono *TRIS*
24V - IP20

6201/BNC



Strip LED COB
Cambiatono *TRIS*
24V - IP68

Accessori per Strip LED COB 24V Cambiatono BNC

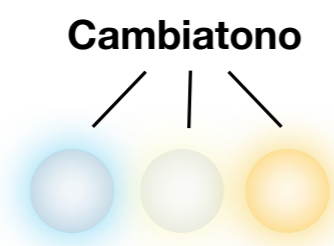

nr pezzi per confezione 1



66014

Connettore lineare
strip COB/ strip COB
Cambiatono BNC

nr pezzi per confezione 1



66015

Connettore angolare
strip COB/ strip COB
Cambiatono BNC

nr pezzi per confezione 1



66016

Connettore flessibile terminale
trasformatore strip COB
Cambiatono BNC

nr pezzi per confezione 1



66017

Connettore intermedio
trasformatore strip COB
Cambiatono BNC

Strip LED COB - Cambiatono 24V

15W
per metro

2000
Lumen/
metro

K
6500
4000
3000

IP 20
IP 68

70.000
ore



Cambiatono



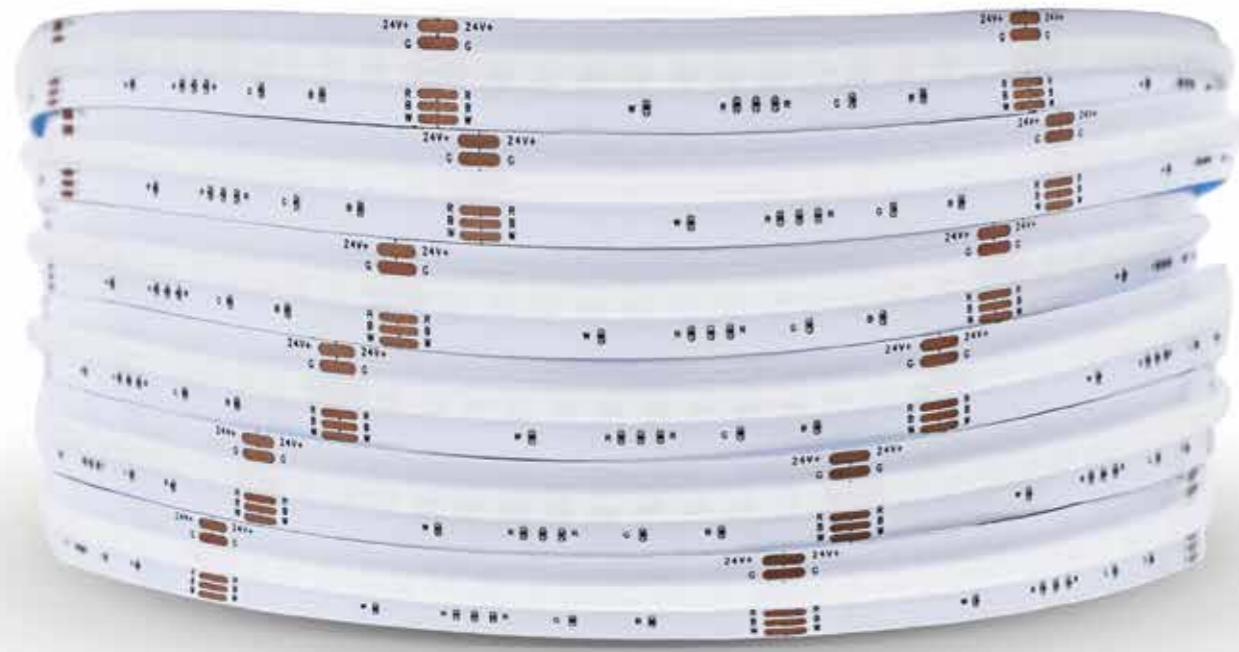

21W per metro

1500/2000 Lumen/metro

6500 K + 4000 3000 + RGB

IP 20

70.000 ore

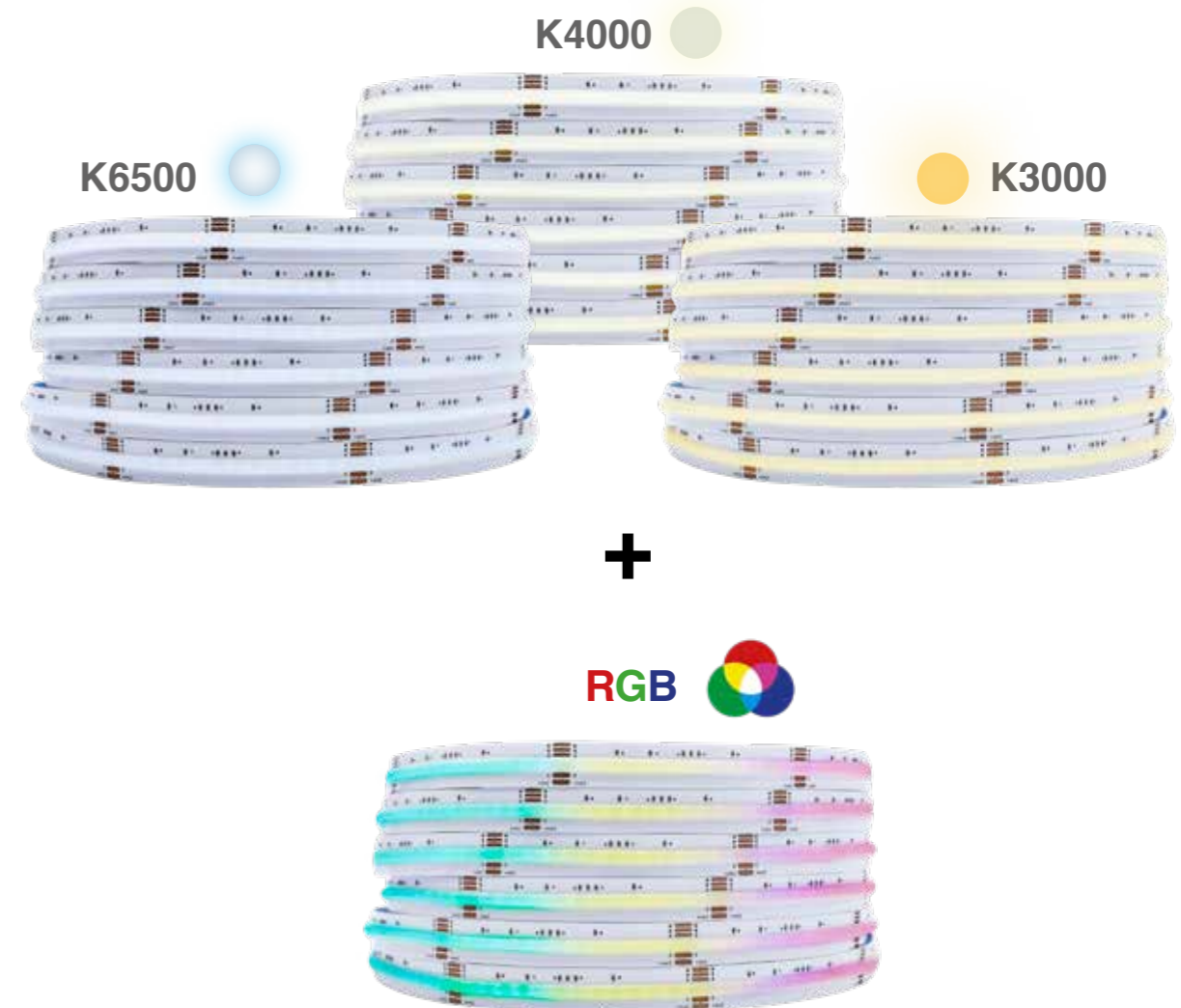

Schema di collegamento

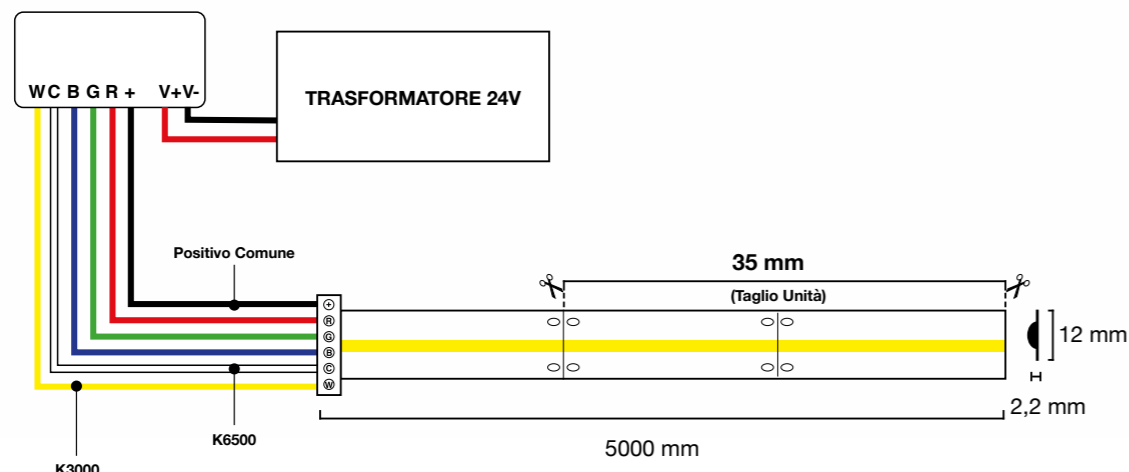

kelvin	6500K + 3000K + 4000K
watt	21W per metro (105Wx 5m tot)
lumen/metro	RGB 1500 Lm/mt BNC 2000 Lm/mt
grado di protezione	IP20
voltaggio	24V
chip LED	COB
lunghezza	5 metri
corpo	PCB
autonomia	70.000 ore

6134/RGB/BNC/24V

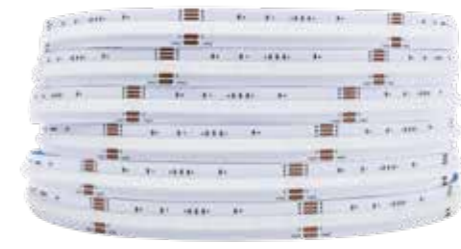

Strip LED COB
Cambiatono + RGB
24V - IP20

Accessori per Strip LED COB 24V Cambiatono BNC

Accessori per Strip LED COB 24V Cambiatono BNC + RGB



nr pezzi per confezione 1



66020

Connettore lineare
strip LED COB
Cambiatono BNC + RGB

nr pezzi per confezione 1



66021

Connettore flessibile terminale
strip LED COB
Cambiatono BNC + RGB

nr pezzi per confezione 1



66022

Connettore flessibile intermedio
strip LED COB
Cambiatono BNC + RGB

Strip LED COB 24V Cambiatono + RGB



Controller per Strip LED Cambiatono BNC e BNC + RGB



Controller per Strip LED Cambiatono BNC e BNC + RGB

Per codici:
 6200/BNC ●
 6201/BNC ●
 6134/RGB/BNC/24V ●



Potente sensore anti-interferenza

Oltre 20 m di controllo senza barriere.

Basso consumo, lungo utilizzo

Schema di collegamento



Controller

input Voltage	DC12/DC24V
potenza	< 25 mA
potenza max output	120/240W
output voltage	Voltaggio costante positivo comune

Telecomando

voltaggio	3V (2 batterie AAA)
potenza	< 10 mA
frequenza	2.4 GHz

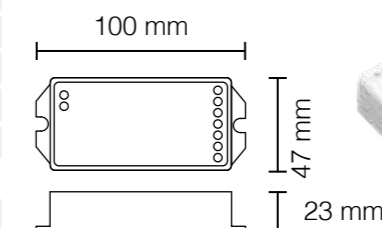

6000/RGB/BNC

Controller per Strip LED RGB + BNC

Strip LED COB 220V 50mt

Strip LED COB 220V 50mt

12W
per metro

1500
Lumen/
metro

220V

IP 65

50.000
ore



kelvin	6500K
watt	12W per metro (600Wx 50m tot)
lumen/metro	1500 Lumen/metro
grado di protezione	IP65
voltaggio	220V
chip LED	COB
lunghezza	50 metri
corpo	PVC
autonomia	50.000 ore
Indice Resa Cromatica	CRI 90



60541

Strip LED COB
24V - IP65

kelvin	4000K
watt	12W per metro (600Wx 50m tot)
lumen/metro	1500 Lumen/metro
grado di protezione	IP65
voltaggio	220V
chip LED	COB
lunghezza	50 metri
corpo	PVC
autonomia	50.000 ore
Indice Resa Cromatica	CRI 90



60551

Strip LED COB
24V - IP65

kelvin	3000K
watt	12W per metro (600Wx 50m tot)
lumen/metro	1500 Lumen/metro
grado di protezione	IP65
voltaggio	220V
chip LED	COB
lunghezza	50 metri
corpo	PVC
autonomia	50.000 ore
Indice Resa Cromatica	CRI 90



60561

Strip LED COB
24V - IP65

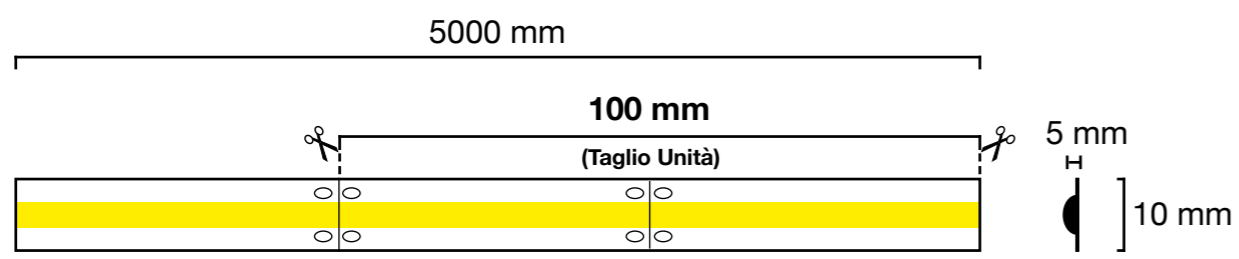

Accessori per Strip LED COB 220V



Collegamento **max 100 mt**
con un solo cavo



nr pezzi per confezione 1

nr pezzi per confezione 2

nr pezzi per confezione 1

nr pezzi per confezione 2

nr pezzi per confezione 1

nr pezzi per confezione 1

nr pezzi per confezione 1

Accessori per Strip LED COB 220V



60851

Cavo
Strip LED COB 220V



6086

Clips di montaggio
Strip LED COB 220V



6087

Silicone
Strip LED COB 220V



60881

Tappi di chiusura
Strip LED COB 220V



60891

Giunto di collegamento lineare
Strip LED COB 220V



60901

Giunto di collegamento angolare
Strip LED COB 220V



60902

Giunto di collegamento da 12mm
Strip LED COB 220V

